



# PMS5N60P / PMS5N60F

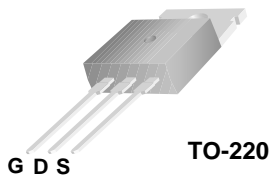
## 600V N-Channel MOSFET

### General Description

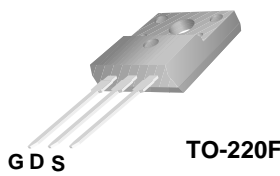
This Power MOSFET is produced using Truesemi's advanced planar stripe DMOS technology. This advanced technology has been especially tailored to minimize on-state resistance, provide superior switching performance, and withstand high energy pulse in the avalanche and commutation mode. These devices are well suited for high efficiency switched mode power supplies, active power factor correction based on half bridge topology.

### Features

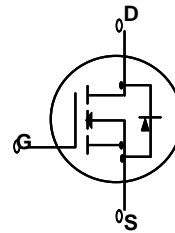
- 4.5A, 600V,  $R_{DS(on)} = 2.50\Omega @ V_{GS} = 10V$
- Low gate charge ( typical 16nC)
- High ruggedness
- Fast switching
- 100% avalanche tested
- Improved dv/dt capability



TO-220



TO-220F



### Absolute Maximum Ratings T<sub>C</sub> = 25°C unless otherwise noted

Symbol	Parameter	PMS5N60P	PMS5N60F	Units
V <sub>DSS</sub>	Drain-Source Voltage	600		V
I <sub>D</sub>	Drain Current - Continuous (T <sub>C</sub> = 25°C)	4.5	4.5*	A
	- Continuous (T <sub>C</sub> = 100°C)	2.7	2.7 *	A
I <sub>DM</sub>	Drain Current - Pulsed (Note 1)	18	18 *	A
V <sub>GSS</sub>	Gate-Source Voltage	± 30		V
E <sub>AS</sub>	Single Pulsed Avalanche Energy (Note 2)	180		mJ
E <sub>AR</sub>	Repetitive Avalanche Energy (Note 1)	10.4		mJ
dv/dt	Peak Diode Recovery dv/dt (Note 3)	4.5		V/ns
P <sub>D</sub>	Power Dissipation (T <sub>C</sub> = 25°C)	104	34	W
	- Derate above 25°C	0.83	0.27	W/°C
T <sub>J</sub> , T <sub>STG</sub>	Operating and Storage Temperature Range	-55 to +150		°C
T <sub>L</sub>	Maximum lead temperature for soldering purposes, 1/8" from case for 5 seconds	300		°C

\* Drain current limited by maximum junction temperature.

### Thermal Characteristics

Symbol	Parameter	PMS5N60P	PMS5N60F	Units
R <sub>θJC</sub>	Thermal Resistance, Junction-to-Case	1.2	3.65	°C/W
R <sub>θCS</sub>	Thermal Resistance, Case-to-Sink Typ.	0.5	--	°C/W
R <sub>θJA</sub>	Thermal Resistance, Junction-to-Ambient	62.5	62.5	°C/W

# PMS5N60P / PMS5N60F

## Electrical Characteristics

$T_C = 25^\circ\text{C}$  unless otherwise noted

Symbol	Parameter	Test Conditions	Min	Typ	Max	Units
<b>Off Characteristics</b>						
$BV_{DSS}$	Drain-Source Breakdown Voltage	$V_{GS} = 0\text{ V}, I_D = 250\ \mu\text{A}$	600	--	--	V
$\Delta BV_{DSS} / \Delta T_J$	Breakdown Voltage Temperature Coefficient	$I_D = 250\ \mu\text{A}$ , Referenced to $25^\circ\text{C}$	--	0.6	--	$\text{V}/^\circ\text{C}$
$I_{DSS}$	Zero Gate Voltage Drain Current	$V_{DS} = 600\text{ V}, V_{GS} = 0\text{ V}$	--	--	1	$\mu\text{A}$
		$V_{DS} = 480\text{ V}, T_C = 125^\circ\text{C}$	--	--	10	$\mu\text{A}$
$I_{GSSF}$	Gate-Body Leakage Current, Forward	$V_{GS} = 30\text{ V}, V_{DS} = 0\text{ V}$	--	--	100	nA
$I_{GSSR}$	Gate-Body Leakage Current, Reverse	$V_{GS} = -30\text{ V}, V_{DS} = 0\text{ V}$	--	--	-100	nA

## On Characteristics

$V_{GS(th)}$	Gate Threshold Voltage	$V_{DS} = V_{GS}, I_D = 250\ \mu\text{A}$	2.0	--	4.5	V
$R_{DS(on)}$	Static Drain-Source On-Resistance	$V_{GS} = 10\text{ V}, I_D = 2.25\text{ A}$	--	2.0	2.5	$\Omega$
$Y_{FS}$	Forward Transconductance	$V_{DS} = 20\text{ V}, I_D = 2.25\text{ A}$	-	4.5	-	S

## Dynamic Characteristics

$C_{iss}$	Input Capacitance	$V_{DS} = 25\text{ V}, V_{GS} = 0\text{ V},$ $f = 1.0\text{ MHz}$	--	560	--	pF
$C_{oss}$	Output Capacitance		--	55	--	pF
$C_{rss}$	Reverse Transfer Capacitance		--	7	--	pF

## Switching Characteristics

$t_{d(on)}$	Turn-On Delay Time	$V_{DD} = 300\text{ V}, I_D = 4.5\text{ A},$ $R_G = 25\ \Omega$	--	10	--	ns
$t_r$	Turn-On Rise Time		--	40	--	ns
$t_{d(off)}$	Turn-Off Delay Time	(Note 4, 5)	--	40	--	ns
$t_f$	Turn-Off Fall Time		--	50	--	ns
$Q_g$	Total Gate Charge	$V_{DS} = 480\text{ V}, I_D = 4.5\text{ A},$ $V_{GS} = 10\text{ V}$	--	16	-	nC
$Q_{gs}$	Gate-Source Charge		--	2.5	--	nC
$Q_{gd}$	Gate-Drain Charge		(Note 4, 5)	--	6.5	--

## Drain-Source Diode Characteristics and Maximum Ratings

$I_S$	Maximum Continuous Drain-Source Diode Forward Current	--	--	4.5	A	
$I_{SM}$	Maximum Pulsed Drain-Source Diode Forward Current	--	--	18.0	A	
$V_{SD}$	Drain-Source Diode Forward Voltage	$V_{GS} = 0\text{ V}, I_S = 4.5\text{ A}$	--	--	1.4	V
$t_{rr}$	Reverse Recovery Time	$V_{GS} = 0\text{ V}, I_S = 4.5\text{ A},$ $dI_F / dt = 100\text{ A}/\mu\text{s}$	--	300	--	ns
$Q_{rr}$	Reverse Recovery Charge	(Note 4)	--	2.0	--	$\mu\text{C}$

### Notes:

1. Repetitive Rating : Pulse width limited by maximum junction temperature
2.  $L = 17\text{ mH}, I_{AS} = 4.5\text{ A}, V_{DD} = 50\text{ V}, R_G = 25\ \Omega$ , Starting  $T_J = 25^\circ\text{C}$
3.  $I_{SD} \leq 4.5\text{ A}, di/dt \leq 200\text{ A}/\mu\text{s}, V_{DD} \leq BV_{DSS}$ , Starting  $T_J = 25^\circ\text{C}$
4. Pulse Test : Pulse width  $\leq 300\ \mu\text{s}$ , Duty cycle  $\leq 2\%$
5. Essentially independent of operating temperature

# Typical Characteristics

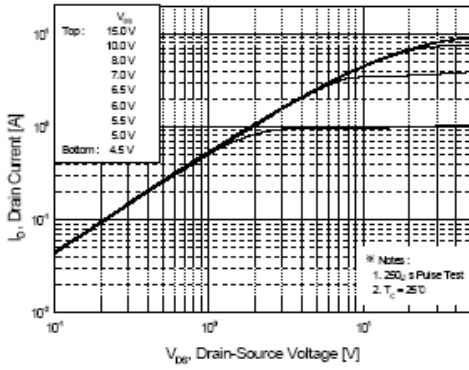


Figure 1. On-Region Characteristics

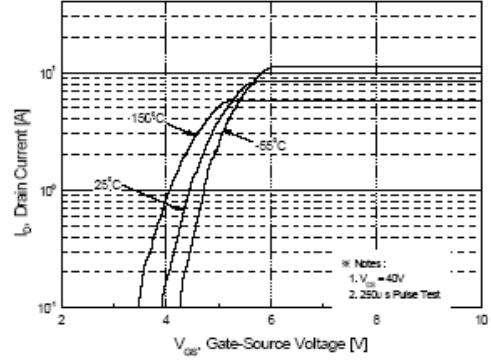


Figure 2. Transfer Characteristics

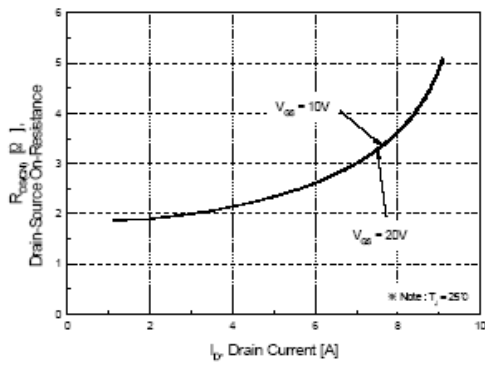


Figure 3. On-Resistance Variation vs Drain Current and Gate Voltage

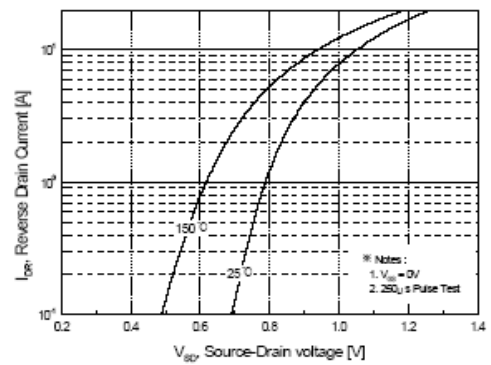


Figure 4. Body Diode Forward Voltage Variation with Source Current

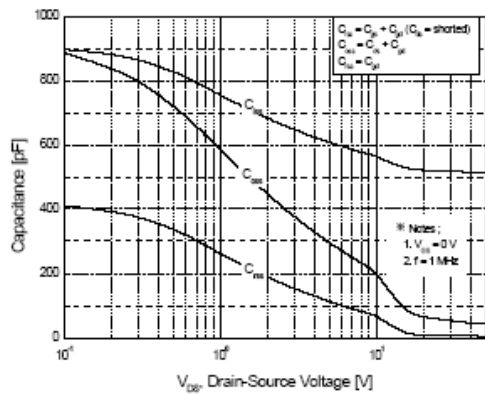


Figure 5. Capacitance Characteristics

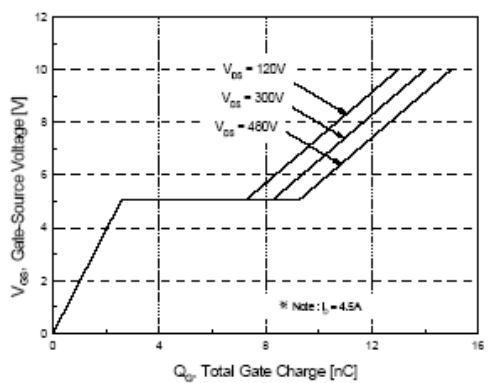
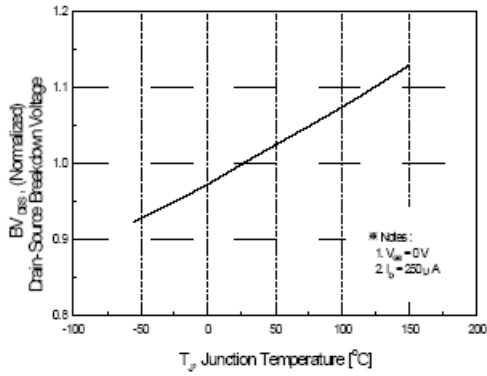
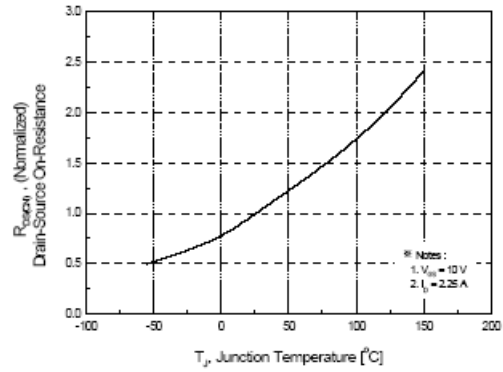


Figure 6. Gate Charge Characteristics

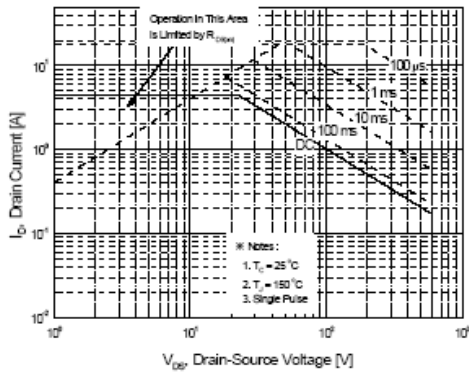
## Typical Characteristics (Continued)



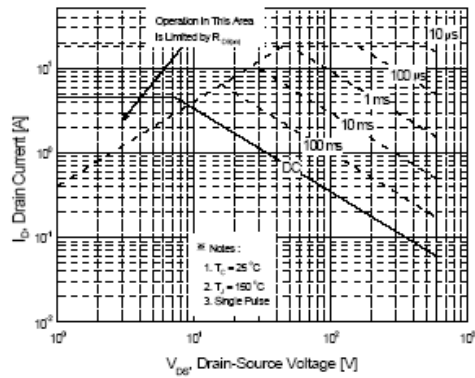
**Figure 7. Breakdown Voltage Variation vs Temperature**



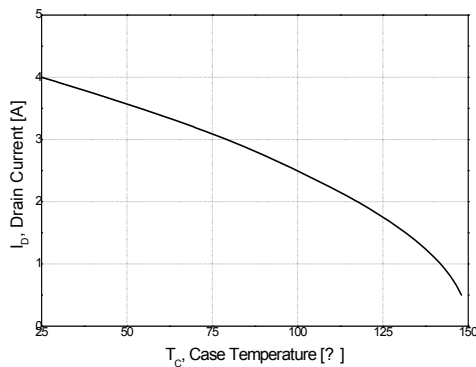
**Figure 8. On-Resistance Variation vs Temperature**



**Figure 9-1. Maximum Safe Operating Area for PMS5N60P**

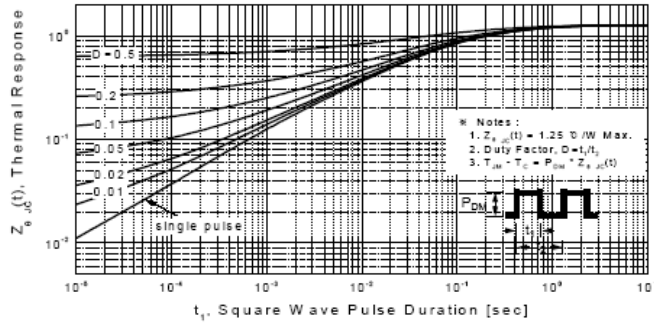


**Figure 9-2. Maximum Safe Operating Area for PMS5N60F**

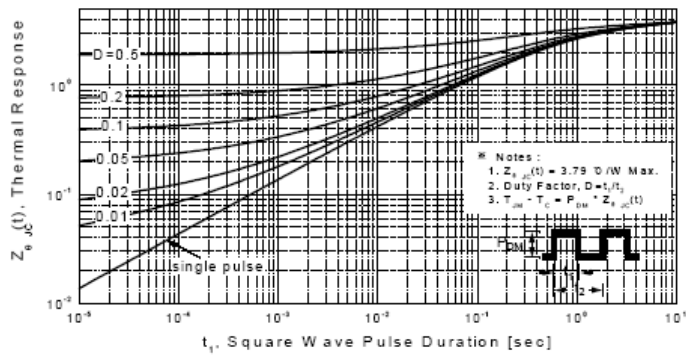


**Figure 10. Maximum Drain Current vs Case Temperature**

**Typical Characteristics** (Continued)

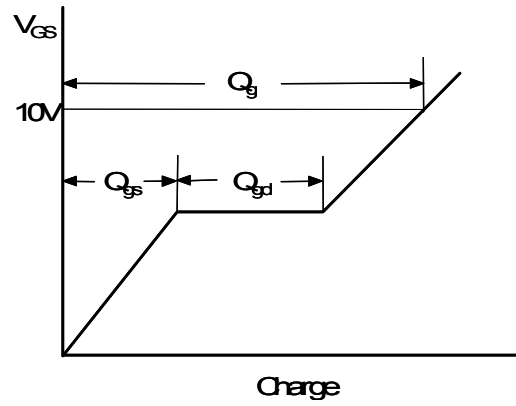
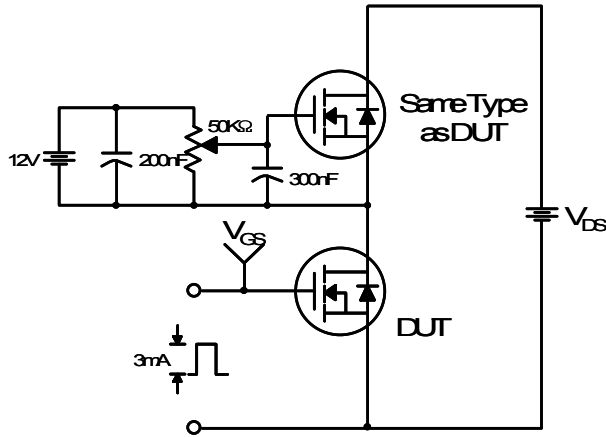


**Figure 11-1. Transient Thermal Response Curve for PMS5N60P**

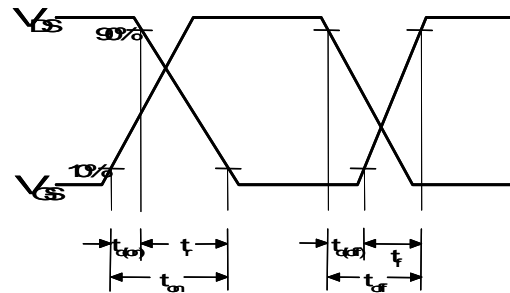
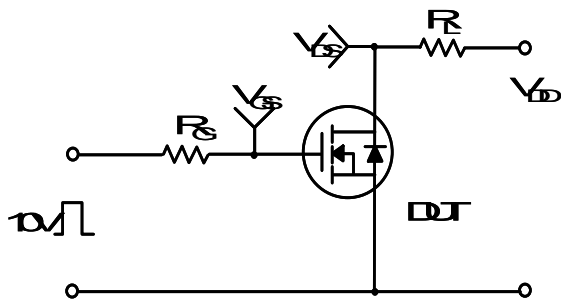


**Figure 11-2. Transient Thermal Response Curve for PMS5N60F**

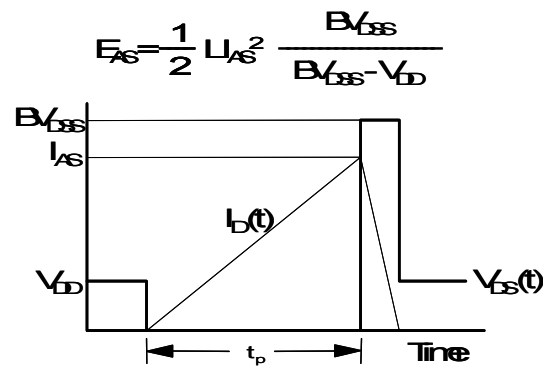
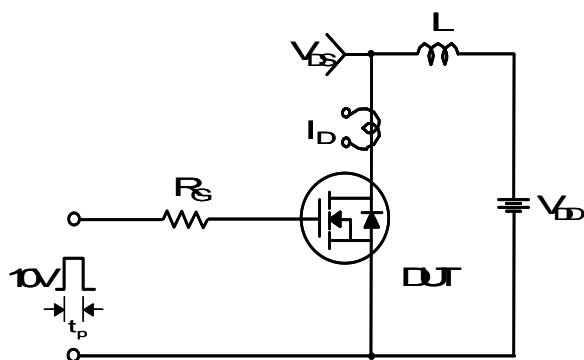
### Gate Charge Test Circuit & Waveform



### Resistive Switching Test Circuit & Waveforms



### Unclamped Inductive Switching Test Circuit & Waveforms



### Peak Diode Recovery dv/dt Test Circuit & Waveforms

