



PMS24N50T

500V N-Channel MOSFET

General Description

This Power MOSFET is produced using Truesemi's advanced planar stripe DMOS technology.

This advanced technology has been especially tailored to minimize on-state resistance, provide superior switching performance, and withstand high energy pulse in the avalanche and commutation mode. These devices are well suited for high efficiency switched mode power supplies, active power factor correction based on half bridge topology.

Features

- 24A, 500V, $R_{DS(on)} = 0.2\Omega @ V_{GS} = 10V$
- Low gate charge (typical 90nC)
- High ruggedness
- Fast switching
- 100% avalanche tested
- Improved dv/dt capability

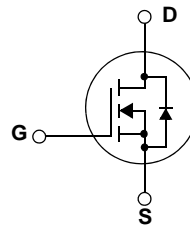
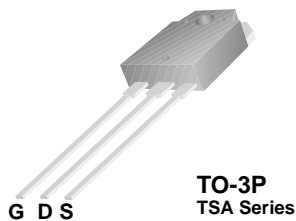

Absolute Maximum Ratings $T_C = 25^\circ\text{C}$ unless otherwise noted

| Symbol | Parameter | PMS24N50T | Units |
|----------------|---|-------------|---------------------|
| V_{DSS} | Drain-Source Voltage | 500 | V |
| I_D | Drain Current - Continuous ($T_C = 25^\circ\text{C}$) - Continuous ($T_C = 100^\circ\text{C}$) | 24 | A |
| | | 15 | A |
| I_{DM} | Drain Current - Pulsed (Note 1) | 96 | A |
| V_{GSS} | Gate-Source Voltage | ± 30 | V |
| E_{AS} | Single Pulsed Avalanche Energy (Note 2) | 1150 | mJ |
| E_{AR} | Repetitive Avalanche Energy (Note 1) | 29 | mJ |
| dv/dt | Peak Diode Recovery dv/dt (Note 3) | 4.5 | V/ns |
| P_D | Power Dissipation ($T_C = 25^\circ\text{C}$) - Derate above 25°C | 290 | W |
| | | 2.33 | W/ $^\circ\text{C}$ |
| T_J, T_{STG} | Operating and Storage Temperature Range | -55 to +150 | $^\circ\text{C}$ |
| T_L | Maximum lead temperature for soldering purposes, 1/8" from case for 5 seconds | 300 | $^\circ\text{C}$ |

* Drain current limited by maximum junction temperature.

Thermal Characteristics

| Symbol | Parameter | Typ | Max | Units |
|-----------------|---|------|------|---------------------------|
| $R_{\theta JC}$ | Thermal Resistance, Junction-to-Case | -- | 0.43 | $^\circ\text{C}/\text{W}$ |
| $R_{\theta CS}$ | Thermal Resistance, Case-to-Sink Typ. | 0.24 | -- | $^\circ\text{C}/\text{W}$ |
| $R_{\theta JA}$ | Thermal Resistance, Junction-to-Ambient | -- | 40 | $^\circ\text{C}/\text{W}$ |

PMS24N50T

Electrical Characteristics

$T_C = 25^\circ\text{C}$ unless otherwise noted

| Symbol | Parameter | Test Conditions | Min | Typ | Max | Units |
|--------------------------------------|---|---|-----|-----|------|---------------------------|
| Off Characteristics | | | | | | |
| BV_{DSS} | Drain-Source Breakdown Voltage | $V_{GS} = 0\text{ V}, I_D = 250\ \mu\text{A}$ | 500 | -- | -- | V |
| $\frac{\Delta BV_{DSS}}{\Delta T_J}$ | Breakdown Voltage Temperature Coefficient | $I_D = 250\ \mu\text{A}$, Referenced to 25°C | -- | 0.5 | -- | $\text{V}/^\circ\text{C}$ |
| I_{DSS} | Zero Gate Voltage Drain Current | $V_{DS} = 500\text{ V}, V_{GS} = 0\text{ V}$ | -- | -- | 1 | μA |
| | | $V_{DS} = 400\text{ V}, T_C = 125^\circ\text{C}$ | -- | -- | 10 | μA |
| I_{GSSF} | Gate-Body Leakage Current, Forward | $V_{GS} = 30\text{ V}, V_{DS} = 0\text{ V}$ | -- | -- | 100 | nA |
| I_{GSSR} | Gate-Body Leakage Current, Reverse | $V_{GS} = -30\text{ V}, V_{DS} = 0\text{ V}$ | -- | -- | -100 | nA |

On Characteristics

| | | | | | | |
|--------------|-----------------------------------|---|-----|------|-----|----------|
| $V_{GS(th)}$ | Gate Threshold Voltage | $V_{DS} = V_{GS}, I_D = 250\ \mu\text{A}$ | 2.0 | -- | 4.5 | V |
| $R_{DS(on)}$ | Static Drain-Source On-Resistance | $V_{GS} = 10\text{ V}, I_D = 12\text{ A}$ | -- | 0.16 | 0.2 | Ω |
| Y_{FS} | Forward Transconductance | $V_{DS} = 20\text{ V}, I_D = 12\text{ A}$ | - | 22 | - | S |

Dynamic Characteristics

| | | | | | | |
|-----------|------------------------------|--|----|------|----|----|
| C_{iss} | Input Capacitance | $V_{DS} = 25\text{ V}, V_{GS} = 0\text{ V},$ $f = 1.0\text{ MHz}$ | -- | 3500 | -- | pF |
| C_{oss} | Output Capacitance | | -- | 520 | -- | pF |
| C_{rss} | Reverse Transfer Capacitance | | -- | 55 | -- | pF |

Switching Characteristics

| | | | | | | | |
|--------------|---------------------|---|-------------|-----|-----|----|----|
| $t_{d(on)}$ | Turn-On Delay Time | $V_{DD} = 250\text{ V}, I_D = 24\text{ A},$ $R_G = 25\ \Omega$ | -- | 100 | -- | ns | |
| t_r | Turn-On Rise Time | | -- | 250 | -- | ns | |
| $t_{d(off)}$ | Turn-Off Delay Time | | (Note 4, 5) | -- | 200 | -- | ns |
| t_f | Turn-Off Fall Time | | (Note 4, 5) | -- | 150 | -- | ns |
| Q_g | Total Gate Charge | $V_{DS} = 400\text{ V}, I_D = 24\text{ A},$ $V_{GS} = 10\text{ V}$ | -- | 85 | - | nC | |
| Q_{gs} | Gate-Source Charge | | (Note 4, 5) | -- | 11 | -- | nC |
| Q_{gd} | Gate-Drain Charge | | (Note 4, 5) | -- | 45 | -- | nC |

Drain-Source Diode Characteristics and Maximum Ratings

| | | | | | | |
|----------|---|---|----|-----|-----|---------------|
| I_S | Maximum Continuous Drain-Source Diode Forward Current | -- | -- | 24 | A | |
| I_{SM} | Maximum Pulsed Drain-Source Diode Forward Current | -- | -- | 96 | A | |
| V_{SD} | Drain-Source Diode Forward Voltage | $V_{GS} = 0\text{ V}, I_S = 24\text{ A}$ | -- | -- | 1.5 | V |
| t_{rr} | Reverse Recovery Time | $V_{GS} = 0\text{ V}, I_S = 24\text{ A},$ $di_F / dt = 100\text{ A}/\mu\text{s}$ | -- | 400 | -- | ns |
| Q_{rr} | Reverse Recovery Charge | (Note 4) | -- | 4.3 | -- | μC |

Notes:

1. Repetitive Rating : Pulse width limited by maximum junction temperature
2. $L = 3.4\text{ mH}, I_{AS} = 24\text{ A}, V_{DD} = 50\text{ V}, R_G = 25\ \Omega$, Starting $T_J = 25^\circ\text{C}$
3. $I_{SD} \leq 24\text{ A}, di/dt \leq 200\text{ A}/\mu\text{s}, V_{DD} \leq BV_{DSS}$, Starting $T_J = 25^\circ\text{C}$
4. Pulse Test : Pulse width $\leq 300\ \mu\text{s}$, Duty cycle $\leq 2\%$
5. Essentially independent of operating temperature

Typical Characteristics

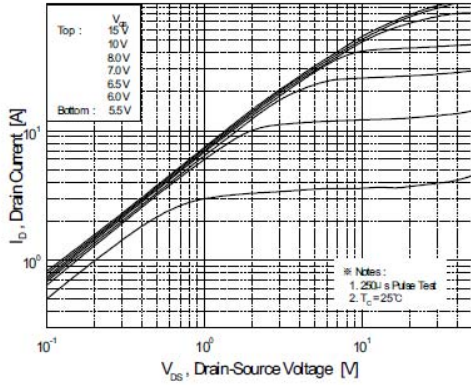

Figure 1. On-Region Characteristics

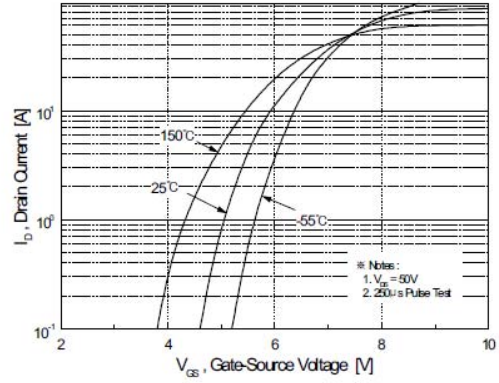

Figure 2. Transfer Characteristics

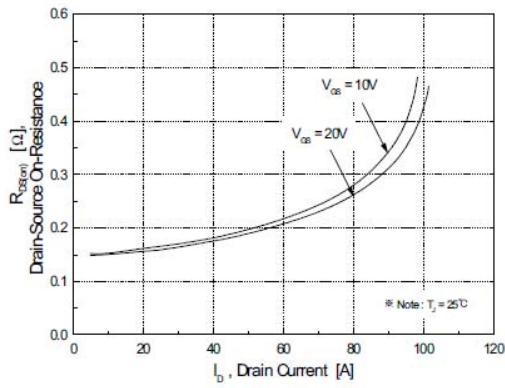

Figure 3. On-Resistance Variation vs. Drain Current and Gate Voltage

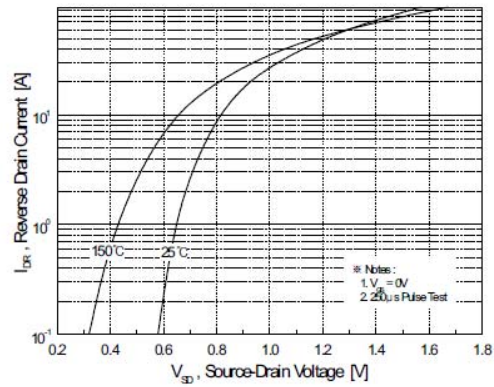

Figure 4. Body Diode Forward Voltage Variation vs. Source Current and Temperature

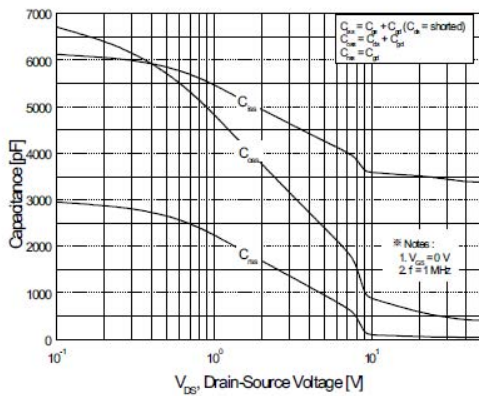

Figure 5. Capacitance Characteristics

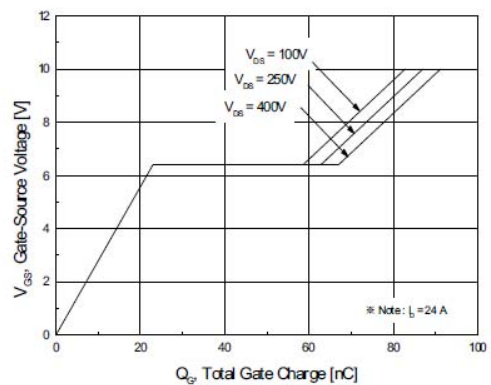

Figure 6. Gate Charge Characteristics

Typical Characteristics (Continued)

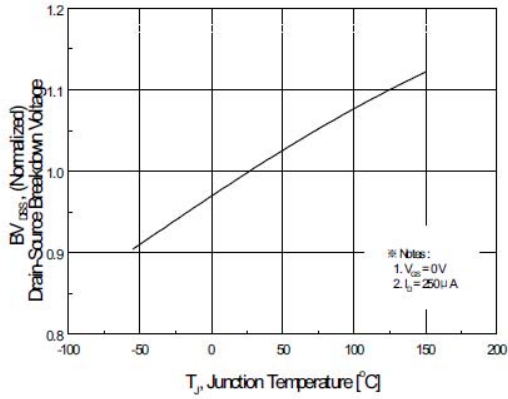

Figure 7. Breakdown Voltage Variation vs. Temperature

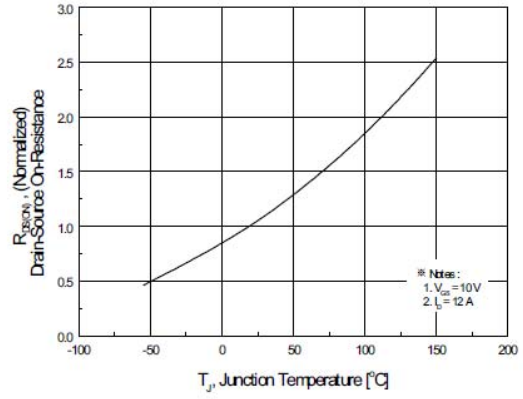

Figure 8. On-Resistance Variation vs. Temperature

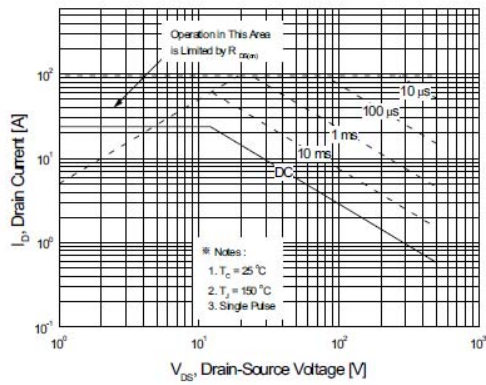

Figure 9. Maximum Safe Operating Area

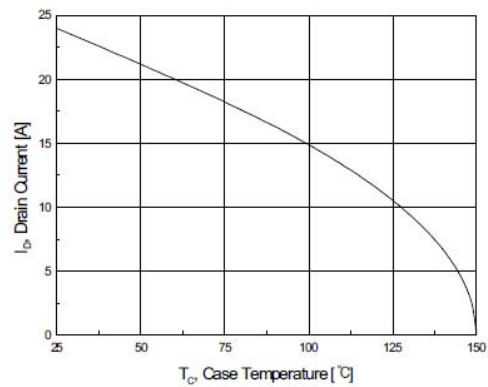

Figure 10. Maximum Drain Current vs. Case Temperature

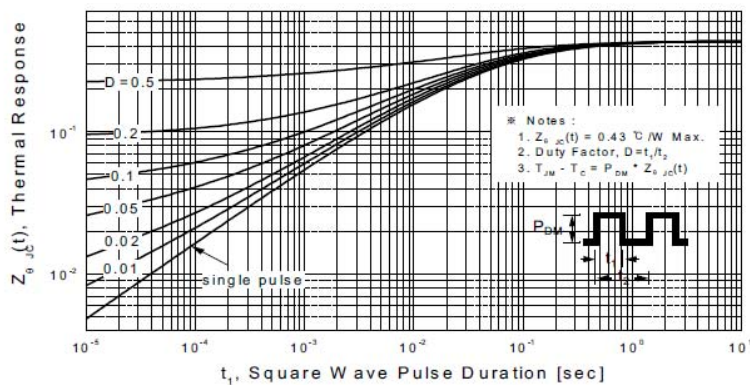
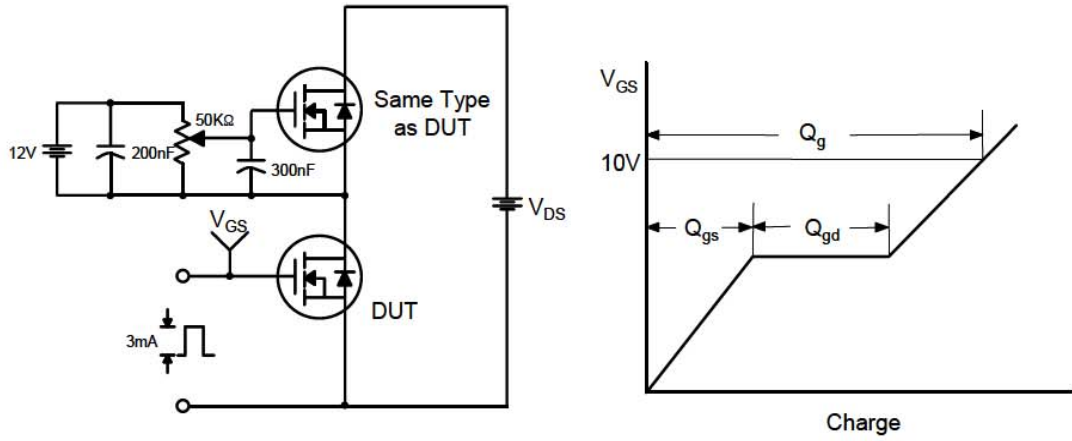
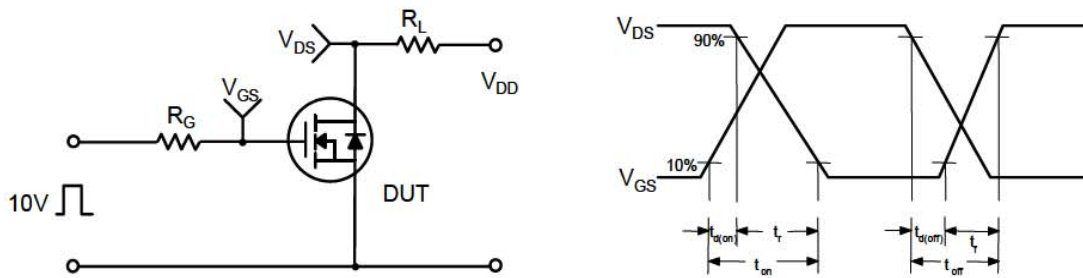

Figure 11. Transient Thermal Response Curve

Gate Charge Test Circuit & Waveform



Resistive Switching Test Circuit & Waveforms



Unclamped Inductive Switching Test Circuit & Waveforms

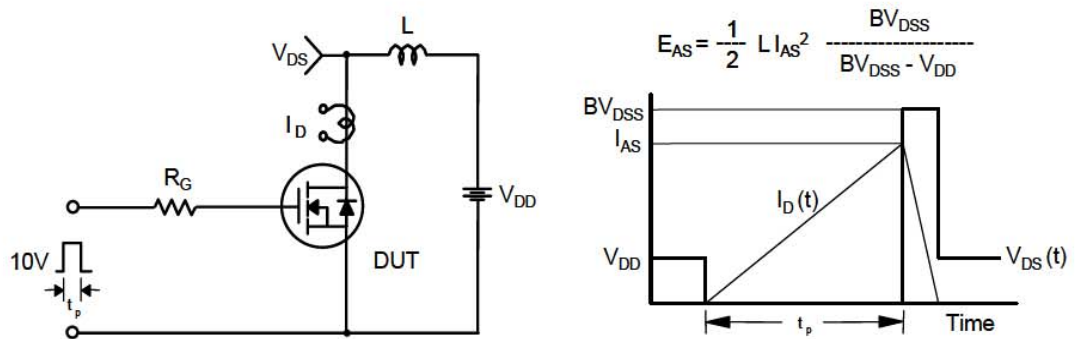

Peak Diode Recovery dv/dt Test Circuit & Waveforms

