



# PMG47N65T N-Channel Enhancement Mode MOSFET

## Features

- TO247 package
- Low  $r_{DS(on)}$
- Ultra Low Gate Charge
- High  $dv/dt$  capability
- High Unclamped Inductive Switching (UIS) capability
- High peak current capability
- Increased transconductance performance
- Optimized design for high performance power systems

Product Summary			
$I_D$	$T_A=25^\circ\text{C}$	47A	Max
$V_{(BR)DSS}$	$I_D=1\text{mA}$	650V	Min
$r_{DS(on)}$	$V_{GS}=10\text{V}$	0.063 $\Omega$	Typ
$Q_g$	$V_{DS}=480\text{V}$	240nC	Typ

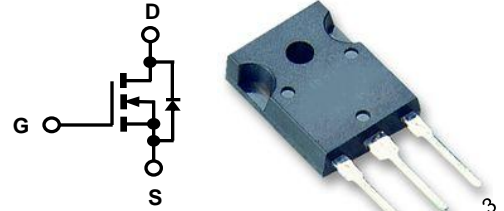

**TO247**  
1:G, 2:D,  
3:S, 4:D,  
(TO-247)

**Maximum ratings**<sup>b</sup>, at  $T_j=25^\circ\text{C}$ , unless otherwise specified

Parameter	Symbol	Conditions	Value	Unit
Continuous drain current	$I_D$	$T_c=25^\circ\text{C}$	47	A
Pulsed drain current	$I_{D, pulse}$	$T_c=25^\circ\text{C}$	82	A
Avalanche energy, single pulse	$E_{AS}$	$I_D=24\text{A}$	1600	mJ
Avalanche current, repetitive	$I_{AR}$	limited by $T_j\text{max}$	24	A
MOSFET $dv/dt$ ruggedness	$dv/dt$	$V_{DS}=480\text{V}$ , $I_D=47\text{A}$ , $T_j=125^\circ\text{C}$	50	V/ns
Gate source voltage	$V_{GS}$	static	$\pm 20$	V
		AC ( $f > 1\text{Hz}$ )	$\pm 30$	
Power dissipation	$P_{tot}$	$T_c=25^\circ\text{C}$	208	W
Operating and storage temperature	$T_j, T_{stg}$		-55 to +150	$^\circ\text{C}$
Mounting torque		M 3 & 3.5 screws	60	Ncm

a When mounted on 1inch square 2oz copper clad FR-4

b Preliminary Data Sheet – Specifications subject to change

Parameter	Symbol	Conditions	Values			Unit
			Min	Typ	Max	

### Thermal characteristics

Thermal resistance, junction-case <sup>a</sup>	$R_{thJC}$		-	-	0.3	°C/W
Thermal resistance, junction-ambient <sup>a</sup>	$R_{thJA}$	leaded	-	-	50	
Soldering temperature, wave soldering only allowed at leads	$T_{sold}$	1.6mm (0.063in.) from case for 10 s	-	-	260	°C

### Electrical characteristics <sup>b</sup>, at $T_j=25^\circ\text{C}$ , unless otherwise specified

#### Static characteristics

Drain-source breakdown voltage	$V_{(BR)DSS}$	$V_{GS}=0\text{ V}, I_D=1\text{ mA}$	650	-	-	V
Gate threshold voltage	$V_{GS(th)}$	$V_{DS}=V_{GS}, I_D=250\mu\text{A}$	2.1	-	3.9	
Zero gate voltage drain current	$I_{DSS}$	$V_{DS}=650\text{ V}, V_{GS}=0\text{ V}, T_j=25^\circ\text{C}$	-	0.1	1	$\mu\text{A}$
		$V_{DS}=650\text{ V}, V_{GS}=0\text{ V}, T_j=150^\circ\text{C}$	-	-	100	
Gate source leakage current	$I_{GSS}$	$V_{GS}=\pm 20\text{ V}, V_{DS}=0\text{ V}$	-	-	100	nA
Drain-source on-state resistance	$R_{DS(on)}$	$V_{GS}=10\text{ V}, I_D=24\text{ A}, T_j=25^\circ\text{C}$	-	0.063	0.07	$\Omega$
		$V_{GS}=10\text{ V}, I_D=24\text{ A}, T_j=150^\circ\text{C}$	-	0.17	-	
Gate resistance	$R_G$	$f=1\text{ MHz}$ , open drain	-	1	-	$\Omega$

#### Dynamic characteristics

Input capacitance	$C_{iss}$	$V_{GS}=0\text{ V}, V_{DS}=25\text{ V}, f=1\text{ MHz}$	-	6600	-	$\mu\text{F}$
Output capacitance	$C_{oss}$		-	2500	-	
Reverse transfer capacitance	$C_{rss}$		-	50	-	
Transconductance	$g_{fs}$	$V_{DS}>2 \cdot I_D \cdot R_{DS}, I_D=24\text{ A}$	-	45	-	S
Turn-on delay time	$t_{d(on)}$	$V_{DS}=380\text{ V}, V_{GS}=10\text{ V}, I_D=47\text{ A}, R_G=4\Omega$ (External)	-	160	-	ns
Rise time	$t_r$		-	25	-	
Turn-off delay time	$t_{d(off)}$		-	20	-	
Fall time	$t_f$		-	25	-	

Parameter	Symbol	Conditions	Values			Unit
			Min	Typ	Max	

### Gate charge characteristics

Gate to source charge	$Q_{gs}$	$V_{DS}=480\text{ V}, I_D=47\text{ A},$ $V_{GS}=0\text{ to }10\text{ V}$	-	11	-	nC
Gate to drain charge	$Q_{gd}$		-	33	-	
Gate charge total	$Q_g$		-	240	-	
Gate plateau voltage	$V_{\text{plateau}}$		-	5.5	-	V

### Reverse Diode

Diode forward voltage	$V_{SD}$	$V_{GS}=0\text{ V}, I_S=I_F$	-	1.0	1.2	V
Reverse recovery time	$t_{rr}$	$V_{RR}=480\text{ V}, I_S=I_F,$ $d_{iF}/d_t=100\text{ A}/\mu\text{S}$	-	700	-	ns
Reverse recovery charge	$Q_{rr}$		-	20	-	$\mu\text{C}$
Peak reverse recovery current	$I_{rm}$		-	70	-	A

Output Characteristics

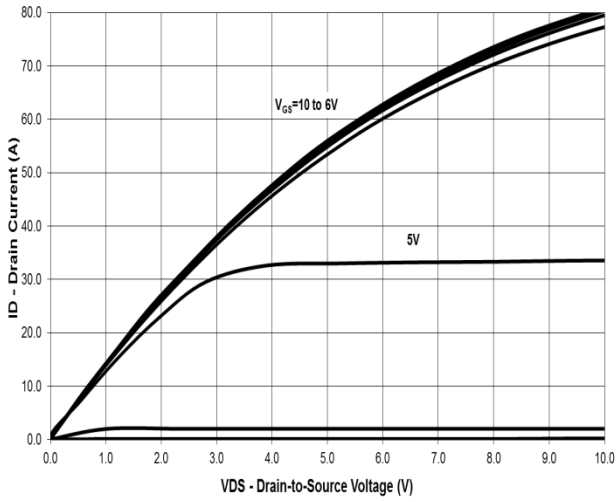

Transfer Characteristics

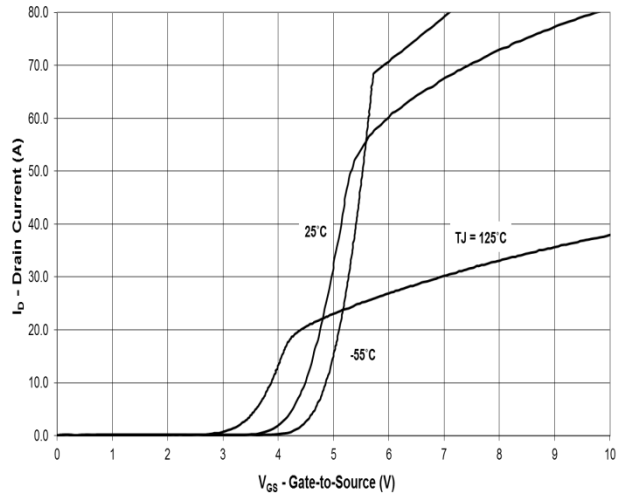

On Resistance vs. Drain Current

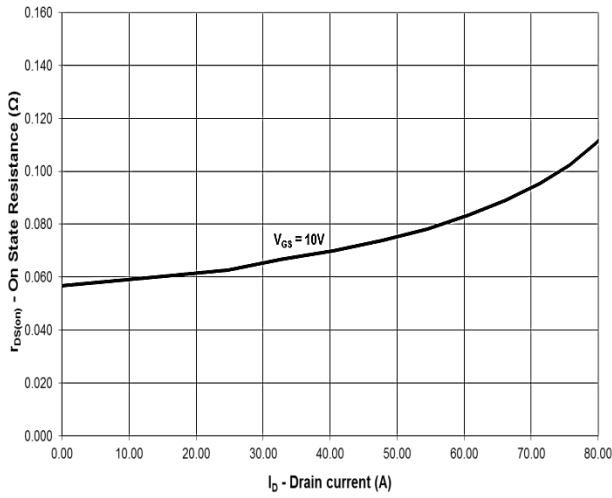

On-State Resistance vs. Junction Temperature

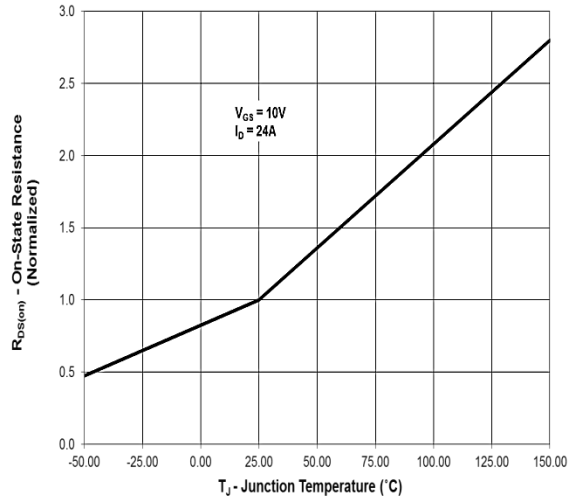

Gate Charge

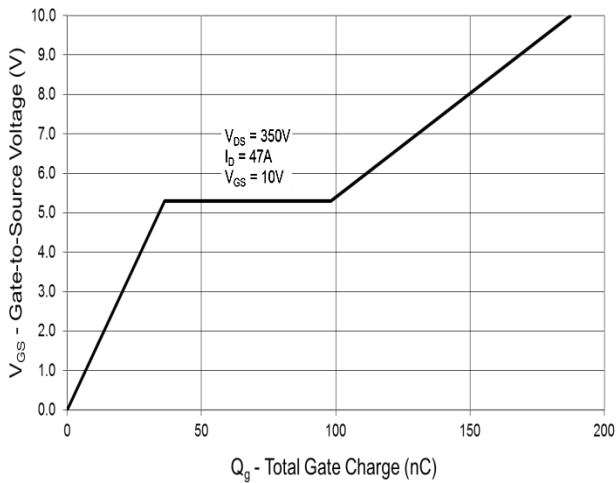

Gate Threshold Voltage vs. Junction Temperature

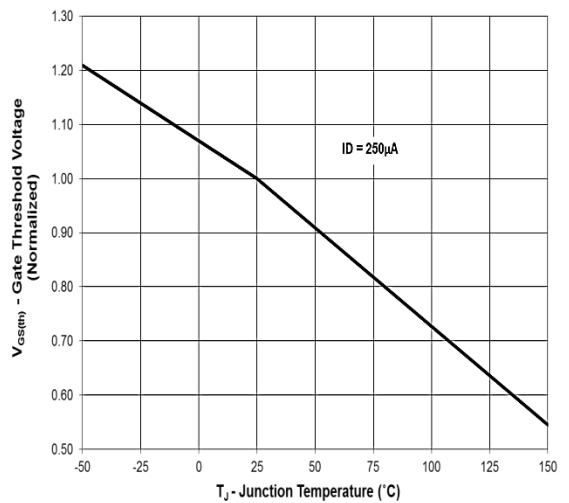

Capacitance

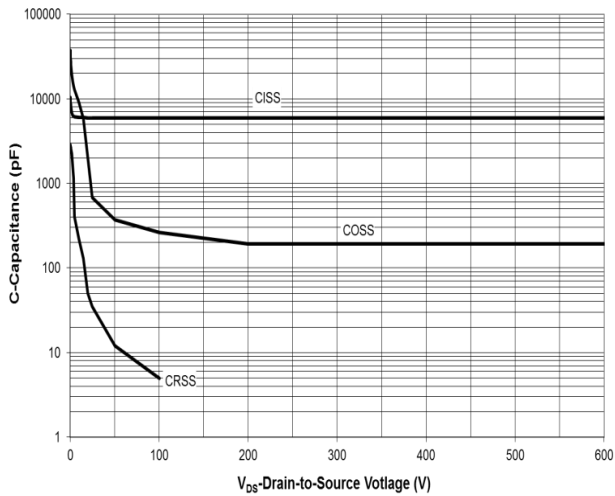

Drain-to-Source Breakdown Voltage vs. Junction Temperature

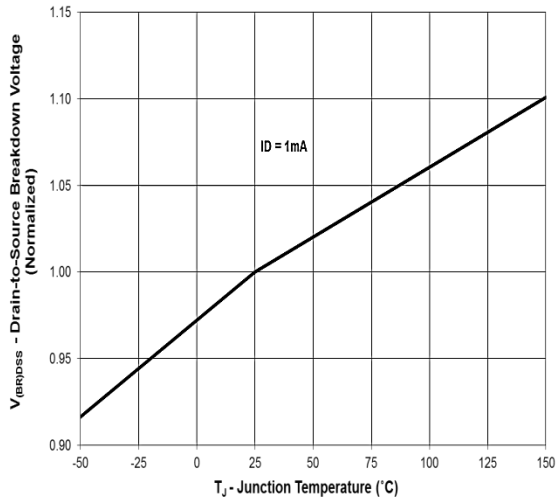

Maximum Rated Forward Biased Safe Operating Area

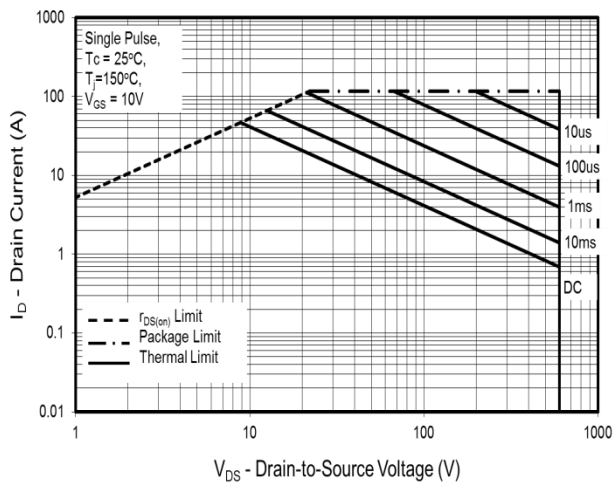

Transient Thermal Response, Junction-to-Case

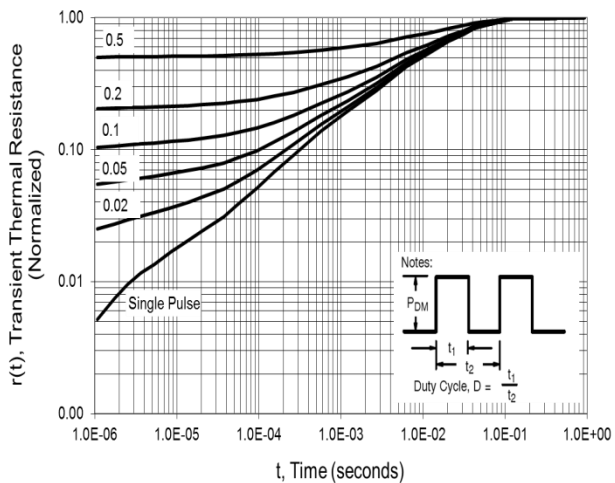

## TO-247 MECHANICAL DATA

DIM.	mm.			inch		
	MIN.	TYP	MAX.	MIN.	TYP.	MAX.
A	4.85		5.15	0.19		0.20
A1	2.20		2.60	0.086		0.102
b	1.0		1.40	0.039		0.055
b1	2.0		2.40	0.079		0.094
b2	3.0		3.40	0.118		0.134
c	0.40		0.80	0.015		0.03
D	19.85		20.15	0.781		0.793
E	15.45		15.75	0.608		0.620
e		5.45			0.214	
L	14.20		14.80	0.560		0.582
L1	3.70		4.30	0.14		0.17
L2		18.50			0.728	
øP	3.55		3.65	0.140		0.143
øR	4.50		5.50	0.177		0.216
S		5.50			0.216	

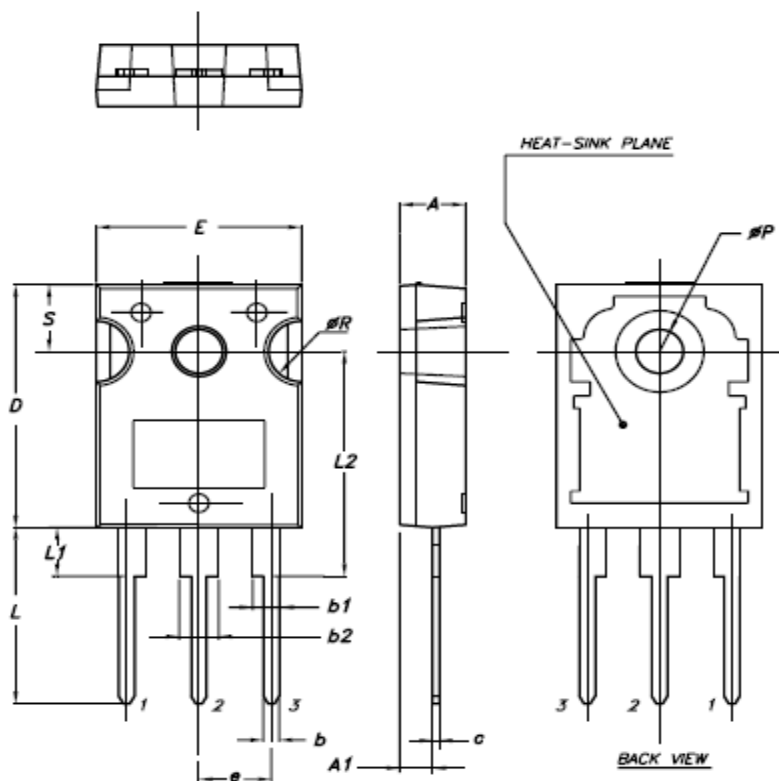

Rev.E