



# PMG17N60P N-Channel Enhancement Mode MOSFET

## Features

- Low  $r_{DS(on)}$
- Ultra Low Gate Charge
- High  $dv/dt$  capability
- High Unclamped Inductive Switching (UIS) capability
- High peak current capability
- Increased transconductance performance
- Optimized design for high performance power systems

Product Summary			
$I_D$	$T_A=25^\circ\text{C}$	17A	Max
$V_{(BR)DSS}$	$I_D=250\mu\text{A}$	600V	Min
$r_{DS(on)}$	$V_{GS}=10\text{V}$	0.19 $\Omega$	Typ
$Q_g$	$V_{DS}=480\text{V}$	59nC	Typ

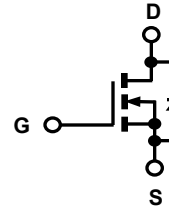

TO220

Standard Metal  
Heatsink

1=Gate, 2=Drain,  
3=Source.

**Maximum ratings**<sup>b</sup>, at  $T_j=25^\circ\text{C}$ , unless otherwise specified

Parameter	Symbol	Conditions	Value	Unit
Continuous drain current	$I_D$	$T_c=25^\circ\text{C}$	17	A
Pulsed drain current	$I_{D, pulse}$	$T_c=25^\circ\text{C}$	40	A
Avalanche energy, single pulse	$E_{AS}$	$I_D=8.5\text{A}$	460	mJ
Avalanche current, repetitive	$I_{AR}$	limited by $T_j\text{max}$	8.5	A
MOSFET $dv/dt$ ruggedness	$dv/dt$	$V_{DS}=480\text{V}$ , $I_D=17\text{A}$ , $T_j=125^\circ\text{C}$	50.0	V/ns
Gate source voltage	$V_{GS}$	static	$\pm 20$	V
		AC ( $f > 1\text{Hz}$ )	$\pm 30$	
Power dissipation	$P_{tot}$	$T_c=25^\circ\text{C}$	186	W
Operating and storage temperature	$T_j, T_{stg}$		-55 to +150	$^\circ\text{C}$
Mounting torque		M 3 & 3.5 screws	60	Ncm

a When mounted on 1inch square 2oz copper clad FR-4

b Preliminary Data Sheet – Specifications subject to change

Parameter	Symbol	Conditions	Values			Unit
			Min	Typ	Max	

### Thermal characteristics

Thermal resistance, junction-case <sup>a</sup>	$R_{thJC}$		-	-	0.8	°C/W
Thermal resistance, junction-ambient <sup>a</sup>	$R_{thJA}$	leaded	-	-	62	
Soldering temperature, wave soldering only allowed at leads	$T_{sold}$	1.6mm (0.063in.) from case for 10 s	-	-	260	°C

### Electrical characteristics <sup>b</sup>, at $T_j=25^{\circ}\text{C}$ , unless otherwise specified

#### Static characteristics

Drain-source breakdown voltage	$V_{(BR)DSS}$	$V_{GS}=0\text{ V}, I_D=250\mu\text{A}$	600	640	-	V
Gate threshold voltage	$V_{GS(th)}$	$V_{DS}=V_{GS}, I_D=250\mu\text{A}$	2.1	3	3.9	
Zero gate voltage drain current	$I_{DSS}$	$V_{DS}=600\text{V}, V_{GS}=0\text{V}, T_j=25^{\circ}\text{C}$	-	0.1	1	$\mu\text{A}$
		$V_{DS}=600\text{V}, V_{GS}=0\text{V}, T_j=150^{\circ}\text{C}$	-	-	100	
Gate source leakage current	$I_{GSS}$	$V_{GS}=\pm 20\text{ V}, V_{DS}=0\text{V}$	-	-	100	nA
Drain-source on-state resistance	$R_{DS(on)}$	$V_{GS}=10\text{V}, I_D=8.5\text{A}, T_j=25^{\circ}\text{C}$	-	0.19	0.22	$\Omega$
		$V_{GS}=10\text{V}, I_D=8.5\text{A}, T_j=150^{\circ}\text{C}$	0.30	0.44	0.60	
Gate resistance	$R_G$	$f=1\text{ MHz}, \text{open drain}$	0.2	0.5	0.7	$\Omega$

#### Dynamic characteristics

Input capacitance	$C_{iss}$	$V_{GS}=0\text{ V}, V_{DS}=25\text{ V}, f=1\text{ MHz}$	-	1800	-	$\mu\text{F}$
Output capacitance	$C_{oss}$		-	600	-	
Reverse transfer capacitance	$C_{rss}$		-	34	-	
Transconductance	$g_{fs}$	$V_{DS}>2 * I_D * R_{DS}, I_D=8.5\text{A}$	10	15	20	S
Turn-on delay time	$t_{d(on)}$	$V_{DS}=380\text{V}, V_{GS}=10\text{V}, I_D=17\text{A}, R_G=4\Omega \text{ (External)}$	3	39	10	ns
Rise time	$t_r$		2	3.5	5	
Turn-off delay time	$t_{d(off)}$		29	55	100	
Fall time	$t_f$		2	7	15	

Parameter	Symbol	Conditions	Values			Unit
			Min	Typ	Max	

### Gate charge characteristics

Gate to source charge	$Q_{gs}$	$V_{DS}=480\text{ V}, I_D=17\text{ A},$ $V_{GS}=10\text{ V}$	5	11	15	nC
Gate to drain charge	$Q_{gd}$		7	15	18	
Gate charge total	$Q_g$		-	59	-	
Gate plateau voltage	$V_{\text{plateau}}$		1.9	4.7	6.8	V

### Reverse Diode

Diode forward voltage	$V_{SD}$	$V_{GS}=0\text{ V}, I_S=I_F$	0.7	0.9	1.2	V
Reverse recovery time	$t_{rr}$	$V_{RR}=480\text{ V}, I_S=I_F,$ $d_{iF}/d_t=100\text{ A}/\mu\text{S}$	150	300	500	ns
Reverse recovery charge	$Q_{rr}$		7	9	11	$\mu\text{C}$
Peak reverse recovery current	$I_{rm}$		40	50	60	A

Output Characteristics

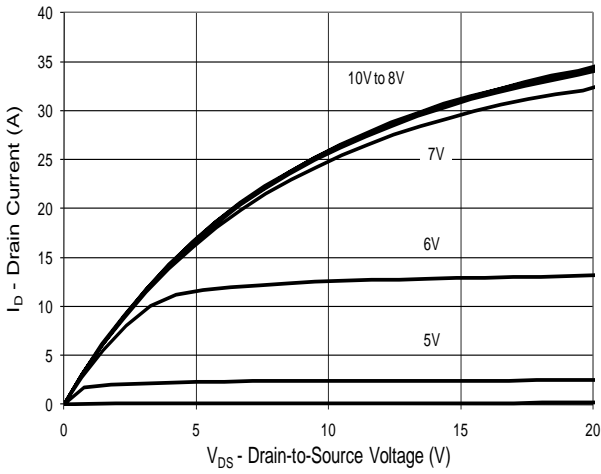

Transfer Characteristics

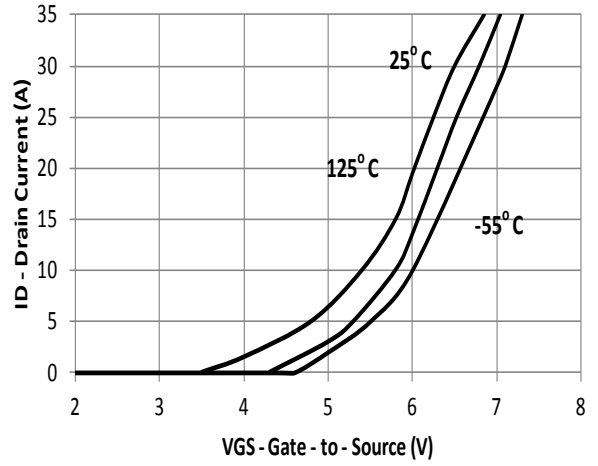

On State Resistance vs. Drain Current

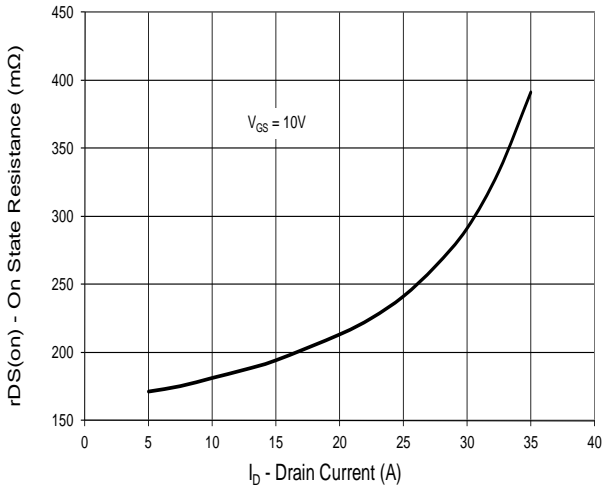

On-State Resistance vs. Junction Temperature

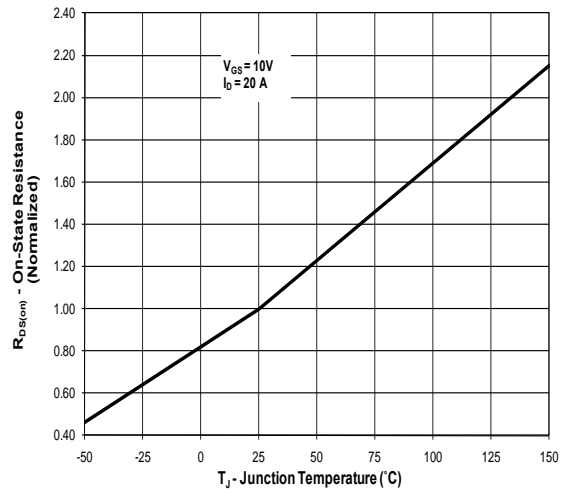

On-Resistance vs. Gate-to-Source Voltage

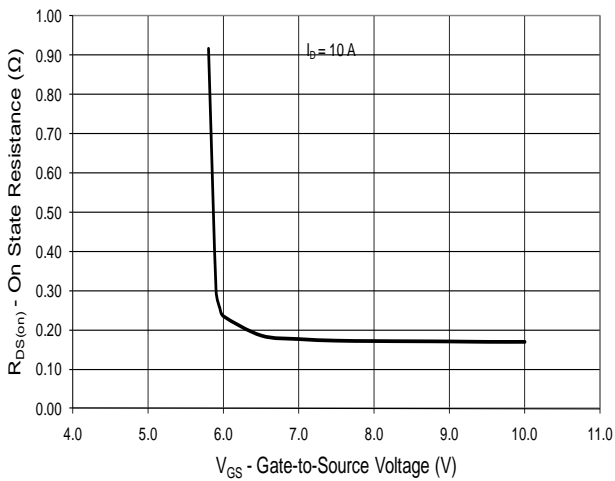

Gate Threshold Voltage vs. Junction Temperature

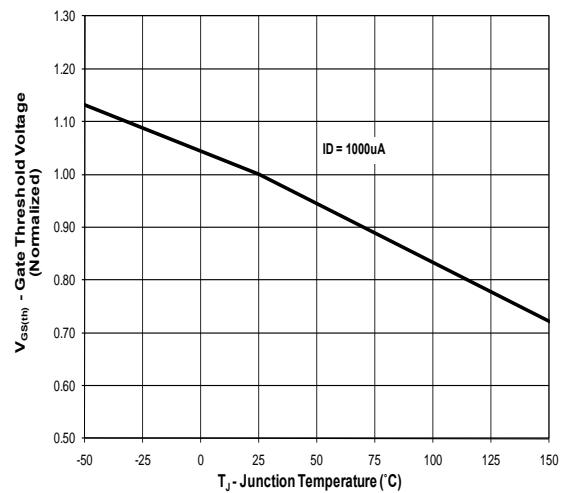

Source-Drain Forward Voltage

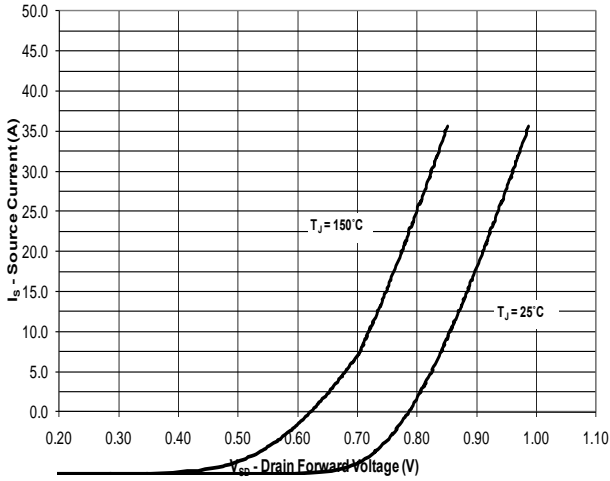

Drain-to-Source Breakdown Voltage vs. Junction Temperature

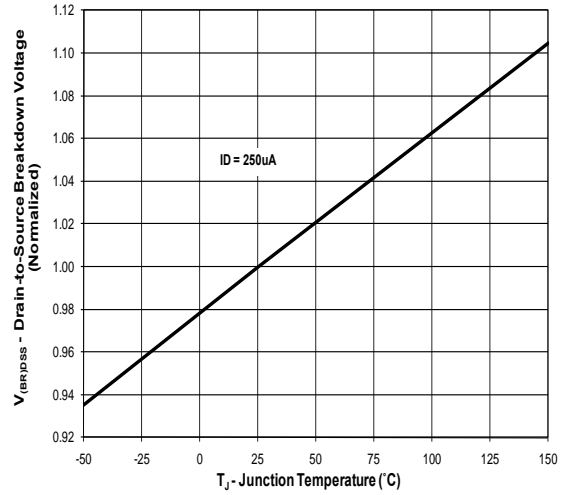

Gate Charge

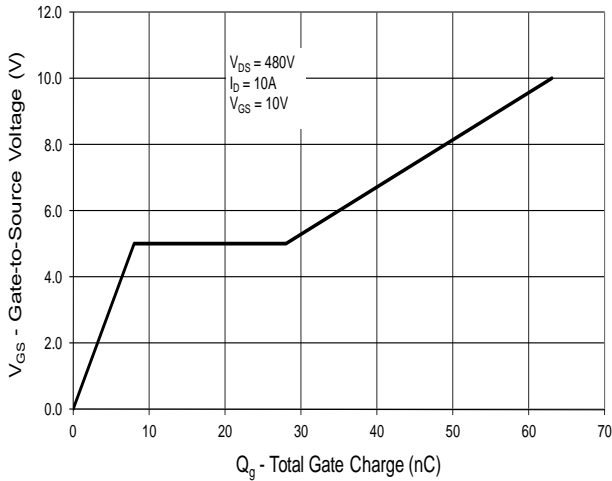

Capacitance

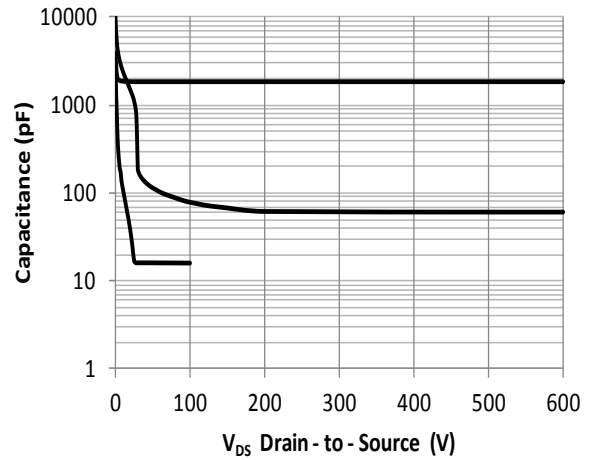

Maximum Rated Forward Biased Safe Operating Area

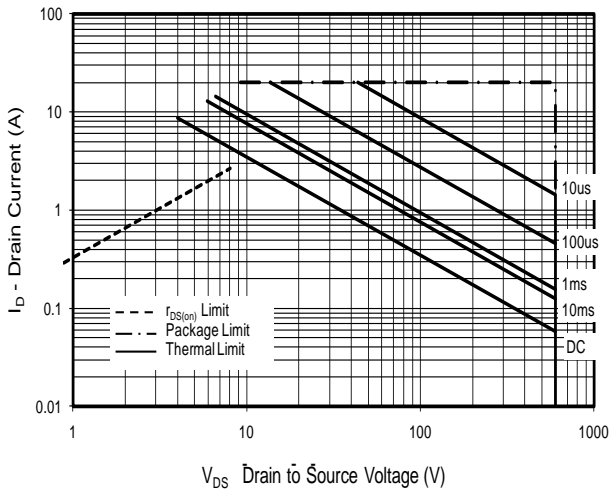

Transient Thermal Response, Junction-to-Case

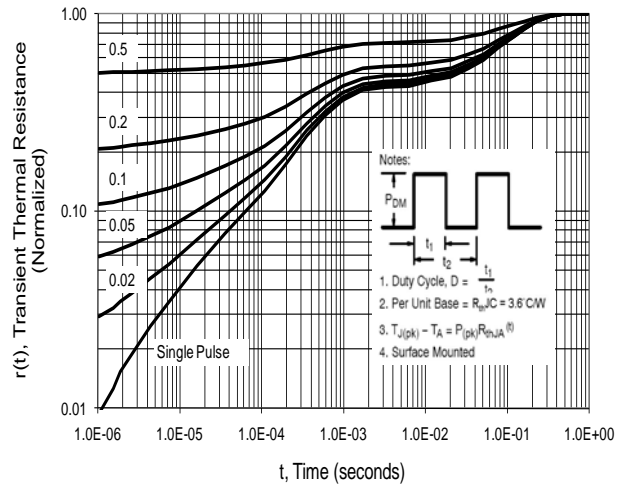

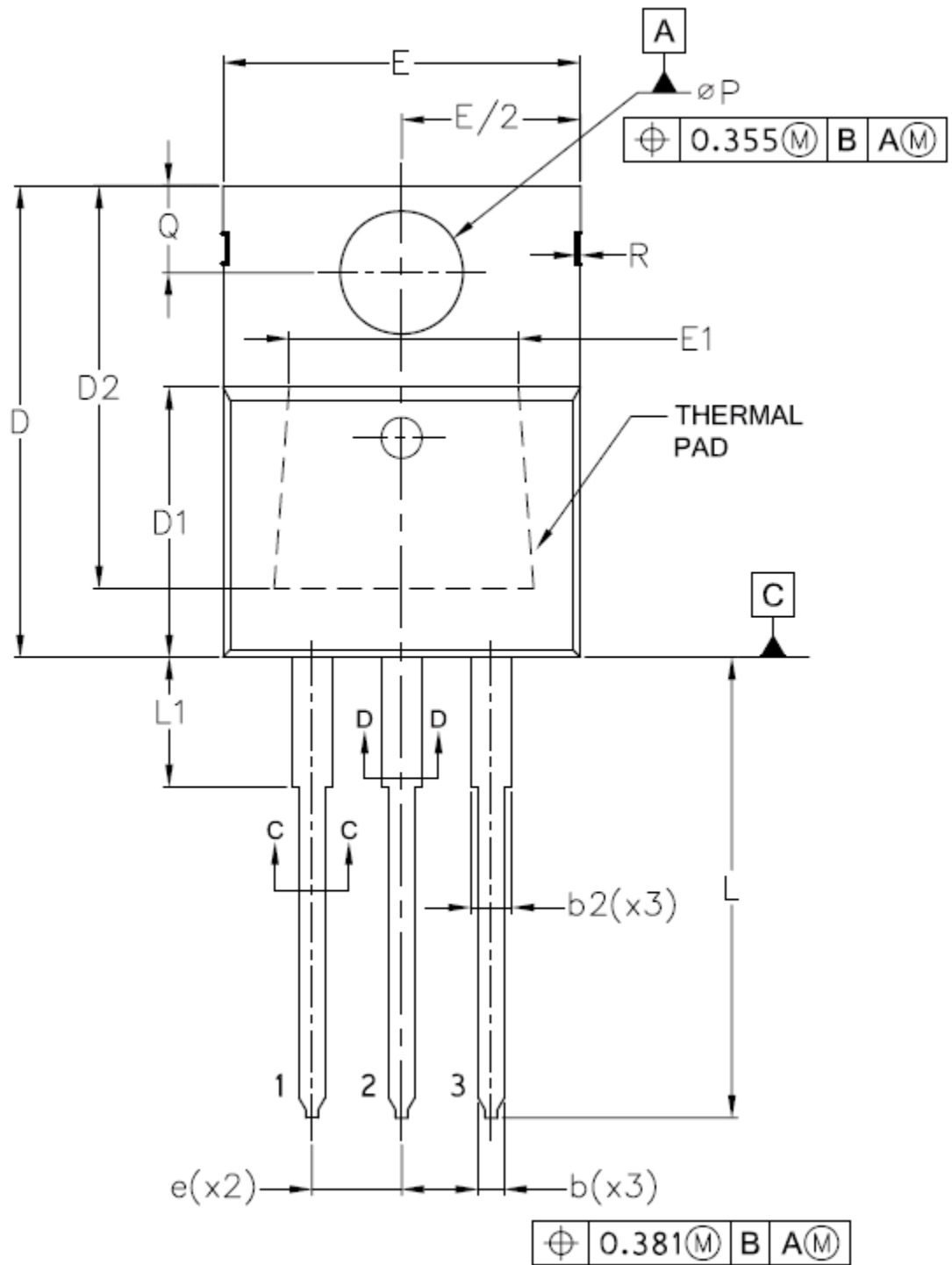

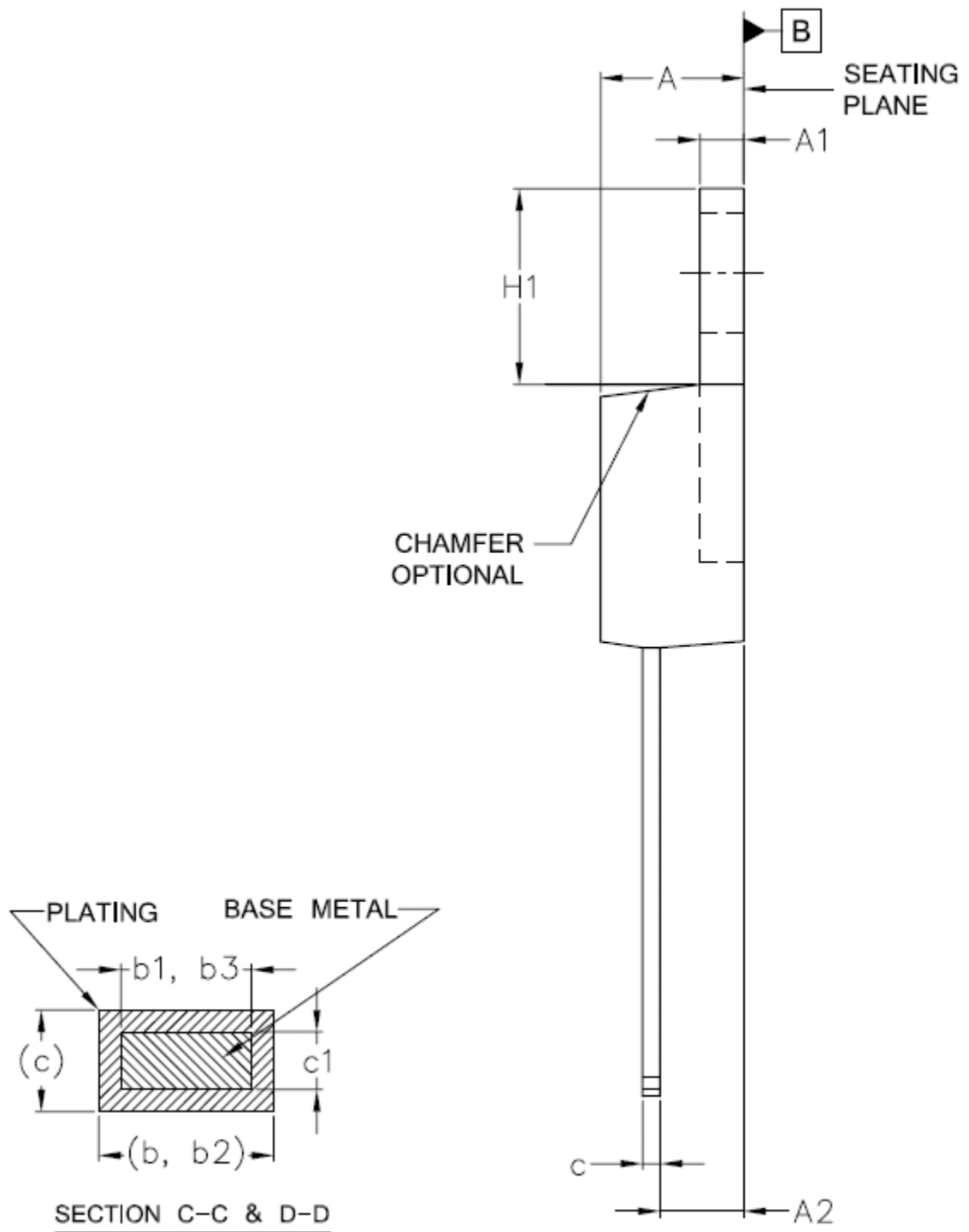

SYMBOLS	DIMENSIONS			
	mm		Inch	
	MIN.	MAX.	MIN.	MAX.
A	3.556	4.826	0.140	0.190
A1	0.508	1.397	0.020	0.055
A2	2.032	2.921	0.080	0.115
b	0.381	1.016	0.015	0.040
b1	0.381	0.965	0.015	0.038
c	0.356	0.610	0.014	0.024
c1	0.356	0.559	0.014	0.022
D	14.224	16.510	0.560	0.650
D1	8.382	9.017	0.330	0.355
D2	12.192	12.878	0.480	0.507
E	9.652	10.668	0.380	0.420
E1	6.858	8.890	0.270	0.350
e	2.540 BSC		0.100 BSC	
H1	5.842	6.858	0.230	0.270
L	12.700	14.732	0.500	0.580
∅P	3.810	3.860	0.150	0.151
Q	2.540	3.048	0.100	0.120
b2	1.143	1.778	0.045	0.070
R	1.270 BSC		0.050 BSC	
L1	–	6.350	–	0.250
b3	1.143	1.727	0.045	0.068
f1	3.200 REF.		0.126 REF.	
f2	4.220 REF.		0.166 REF.	
j	1.750 REF.		0.069 REF.	
r	0.510 REF.		0.020 REF.	
N	TO-220-3L			