



PMG15N60P N-Channel Enhancement Mode MOSFET

Product Summary			
I_D	$T_A=25^\circ\text{C}$	15A	Max
$V_{(BR)DSS}$	$I_D=250\mu\text{A}$	600V	Min
$r_{DS(on)}$	$V_{GS}=10\text{V}$	0.23 Ω	Typ

Features

- Low $r_{DS(on)}$
- Ultra Low Gate Charge
- High dV/dt capability
- High Unclamped Inductive Switching (UIS) capability
- High peak current capability
- Increased transconductance performance
- Optimized design for high performance power systems

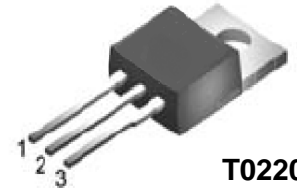
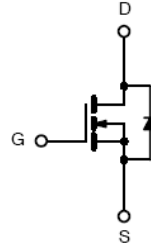

TO220

Standard Metal Heatsink

1=Gate, 2=Drain, 3=Source.

Maximum Ratings and Thermal Characteristics ^b ($T_A=25^\circ\text{C}$ unless otherwise noted)

Parameter	Symbol	Limit	Unit	
Drain-Source Voltage	VDS	600	V	
Gate-Source Voltage (Static)	VGS	± 20	V	
Gate-Source Voltage AC ($f > 1\text{Hz}$)	VGS	± 30	V	
Drain Current	- Continuous ($T_c = 25^\circ\text{C}$)	ID	15	A
	- Pulsed (limited by T_{jmax})	IDM	35	A
Repetitive Avalanche Current (limited by T_{jmax})	IAR	7.5	A	
Energy in Avalanche (single pulse, $I_D = 7.5\text{A}$)	EAS	460	mJ	
Maximum Power Dissipation ($T_c = 25^\circ\text{C}$)	PD	160	W	
Operating Junction and Storage Temperature Range	T_J, T_{stg}	-55 to 150	$^\circ\text{C}$	
dV/dt voltage slope ($V_{ds}=480\text{V}, I_D=15\text{A}, T_j = 125^\circ\text{C}$)	dV/dt	50	V/ns	
Thermal Resistance - Junction-to-Ambient	RthJA	39.00	$^\circ\text{C/W}$	
Thermal Resistance - Junction-to-Case	RthJC	2.00	$^\circ\text{C/W}$	

a When mounted on 1 inch square 2oz copper clad FR-4

b Preliminary Data Sheet - Specifications subject to change.

Electrical Characteristics^b (T_J=25°C unless otherwise specified)

Symbol	Parameter	Test Condition	Min	Typ	Max	Units
V _{(BR)DSS}	Drain-to-Source Breakdown Voltage	V _{GS} =0V, I _D =250uA	600	640		V
I _{DSS}	Zero Gate Voltage Drain Current	V _{DS} =600V, V _{GS} =0V T _J = 150°C		0.1	1	μA
I _{GSS}	Gate-Source Leakage	V _{GS} =±20V, V _{DS} =0V			100	nA
V _{GS(th)}	Gate Threshold Voltage	V _{DS} =V _{GS} , I _D =250uA	2.1	3	3.9	V
r _{DS(on)}	Drain-to-Source On-State Resistance	V _{GS} =10V, I _D =7.5A T _J = 150°C	210	230	250	mΩ
R _G	Gate Resistance	f = 1MHz,	0.2	0.5	0.7	Ω
g _{fs}	Transconductance	V _{DS} > 2*I _D *R _{DS} , I _D = 7.5A	9	14	19	S
C _{iss}	Input Capacitance	V _{DS} =25V, V _{GS} =0V, f=1MHz	1200	1400	1600	pF
C _{oss}	Output Capacitance		480			pF
C _{rss}	Reverse Transfer Capacitance		31			pF
t _{d(on)}	Turn-On Delay Time	V _{GS} =10V, I _D =15A, V _{DS} =380V R _G = 4Ω (External)	17	39	58	nS
t _r	Rise Time		5	10	15	nS
t _{d(off)}	Turn-Off Delay Time		35	55	75	nS
t _f	Fall Time		4	6	9	nS
Q _g	Total Gate Charge	V _{GS} =10V, I _D =15A, V _{DS} =480V	29	54	73	nC
Q _{gs}	Gate-to-Source Charge		7	11	17	nC
Q _{gd}	Gate-to-Drain Charge		11	15	32	nC
V _(plateau)	Gate Plateau voltage		1.9	4.7	6.8	V
t _{rr}	Source-to-Drain Reverse Recovery Time	I _S =I _F , di/dt=100A/uS, V _{rr} =480V	150	300	500	nS
Q _{rr}	Reverse recovery charge		7	9	11	μC
I _{rm}	Peak reverse recovery current		40	50	60	A
V _{SD}	Diode Forward Voltage	I _S =I _F , V _{GS} =0V	0.7	0.9	1.2	V

Output Characteristics

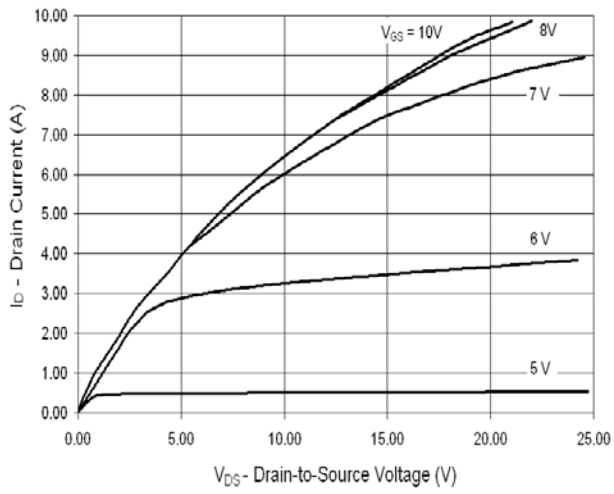

Transfer Characteristics

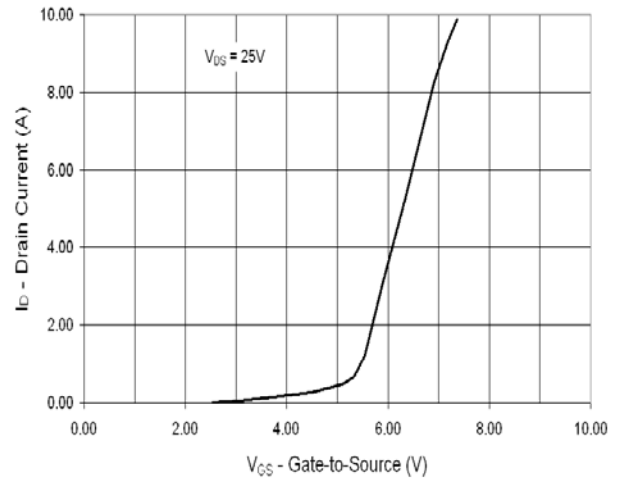

On State Resistance vs. Drain Current

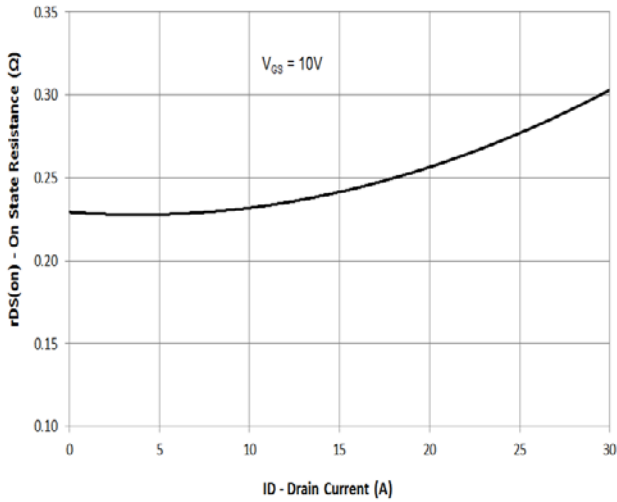

On State Resistance vs. Junction Temperature

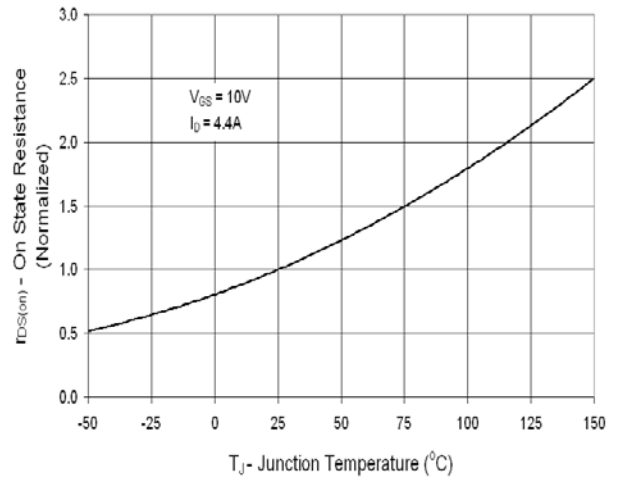

Gate Charge

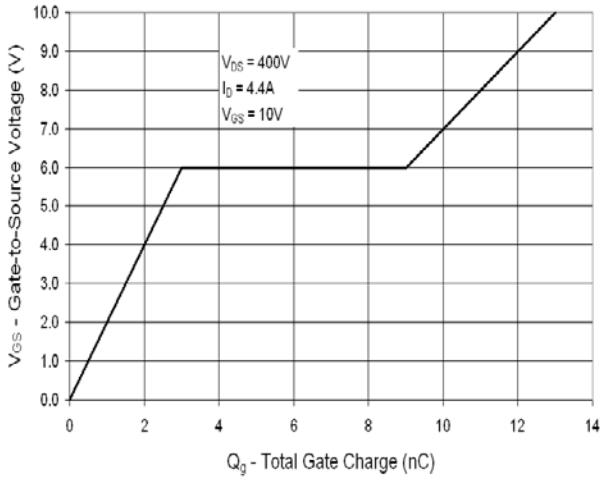

Gate Threshold Voltage vs. Junction Temperature

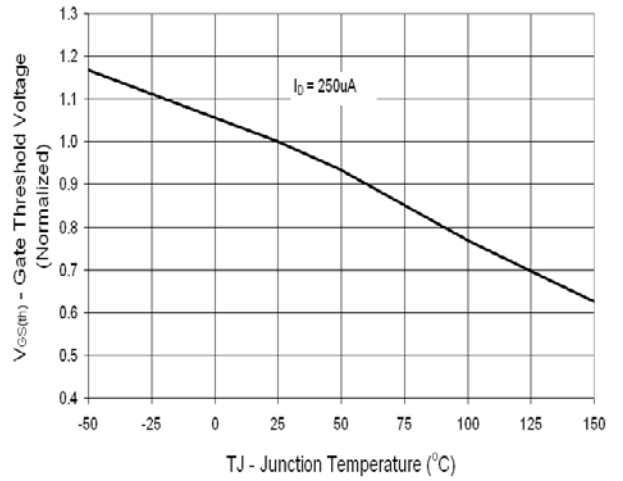

Capacitance

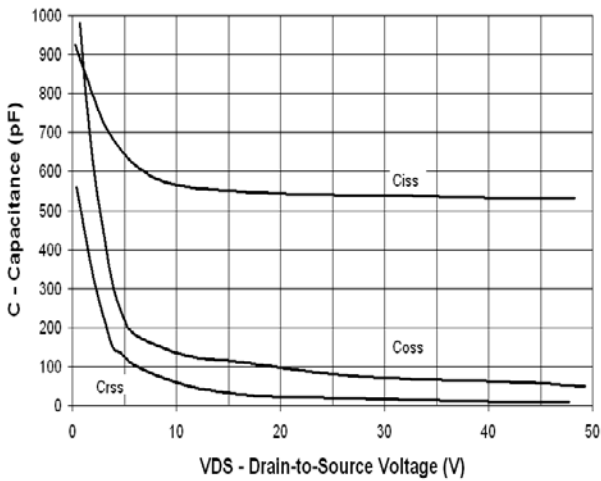

Drain-to-Source Breakdown Voltage vs. TJ

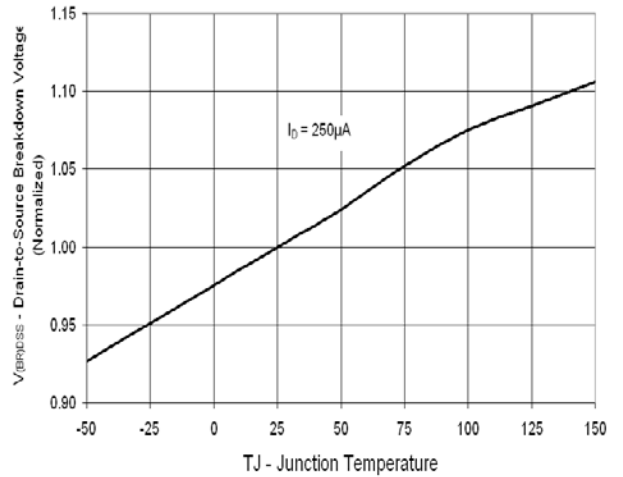

Maximum Rated Forward Biased Safe Operating Area

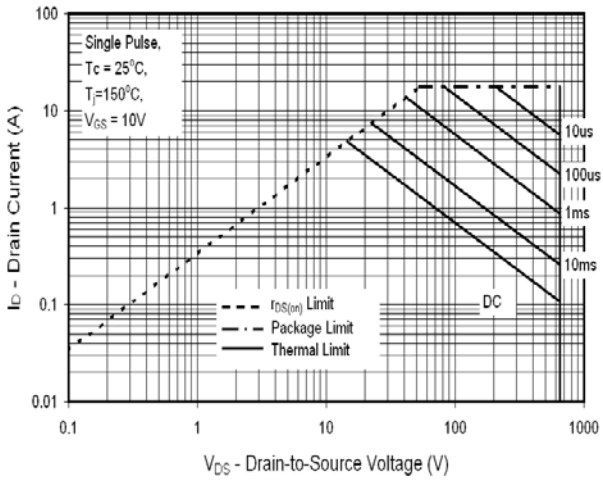

Transient Thermal Response, Junction-to-Case

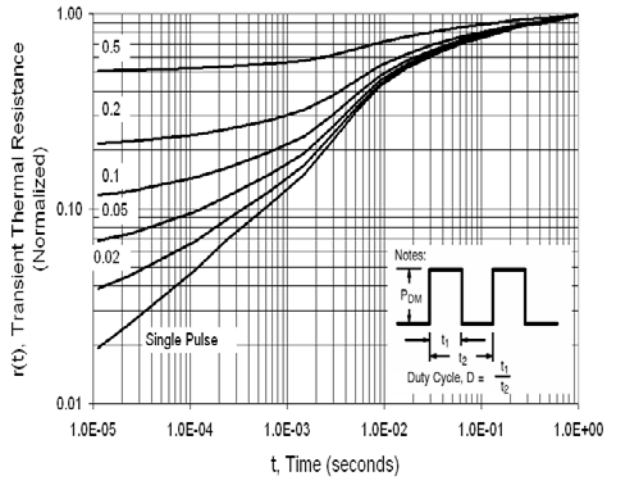

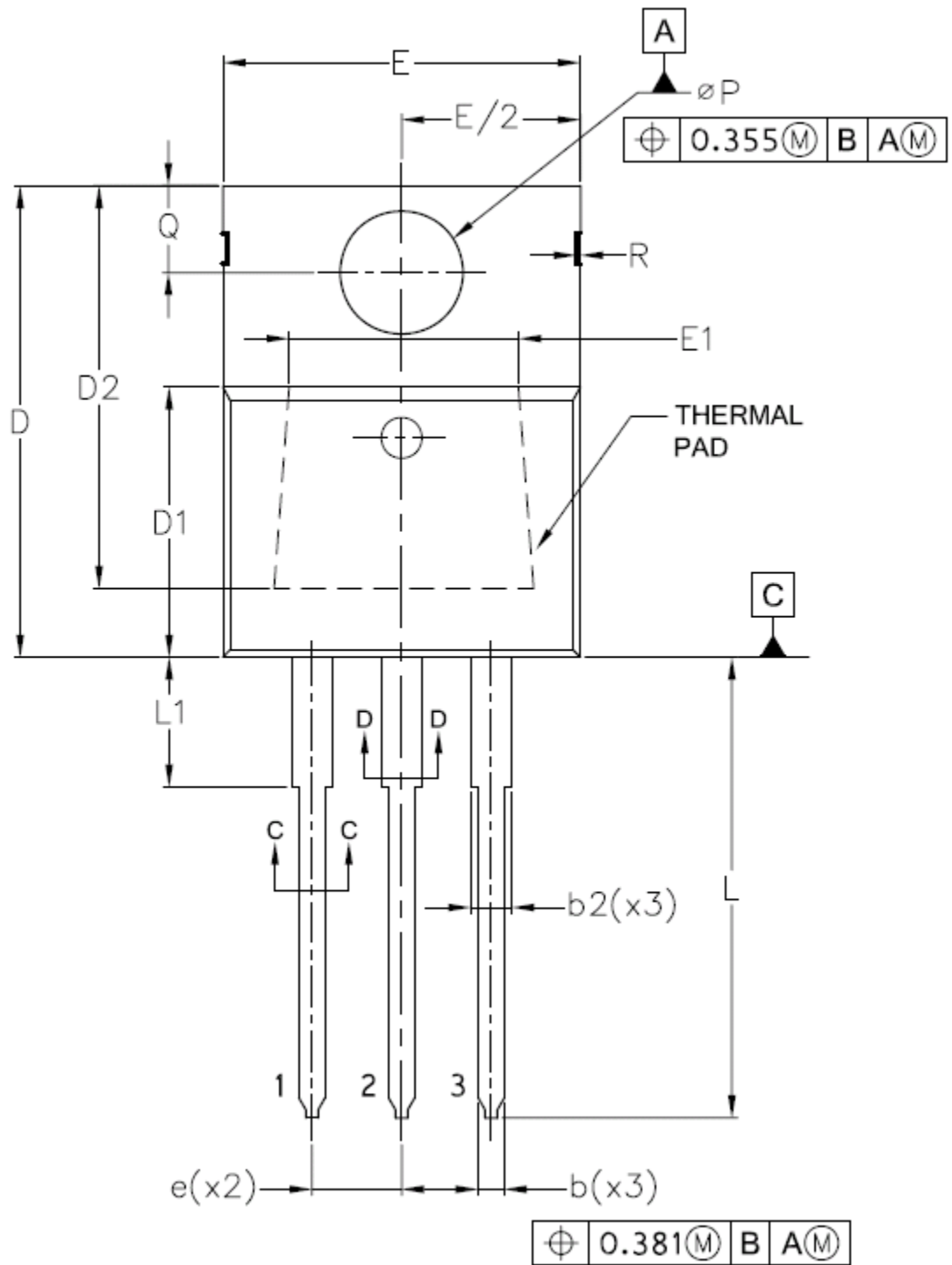

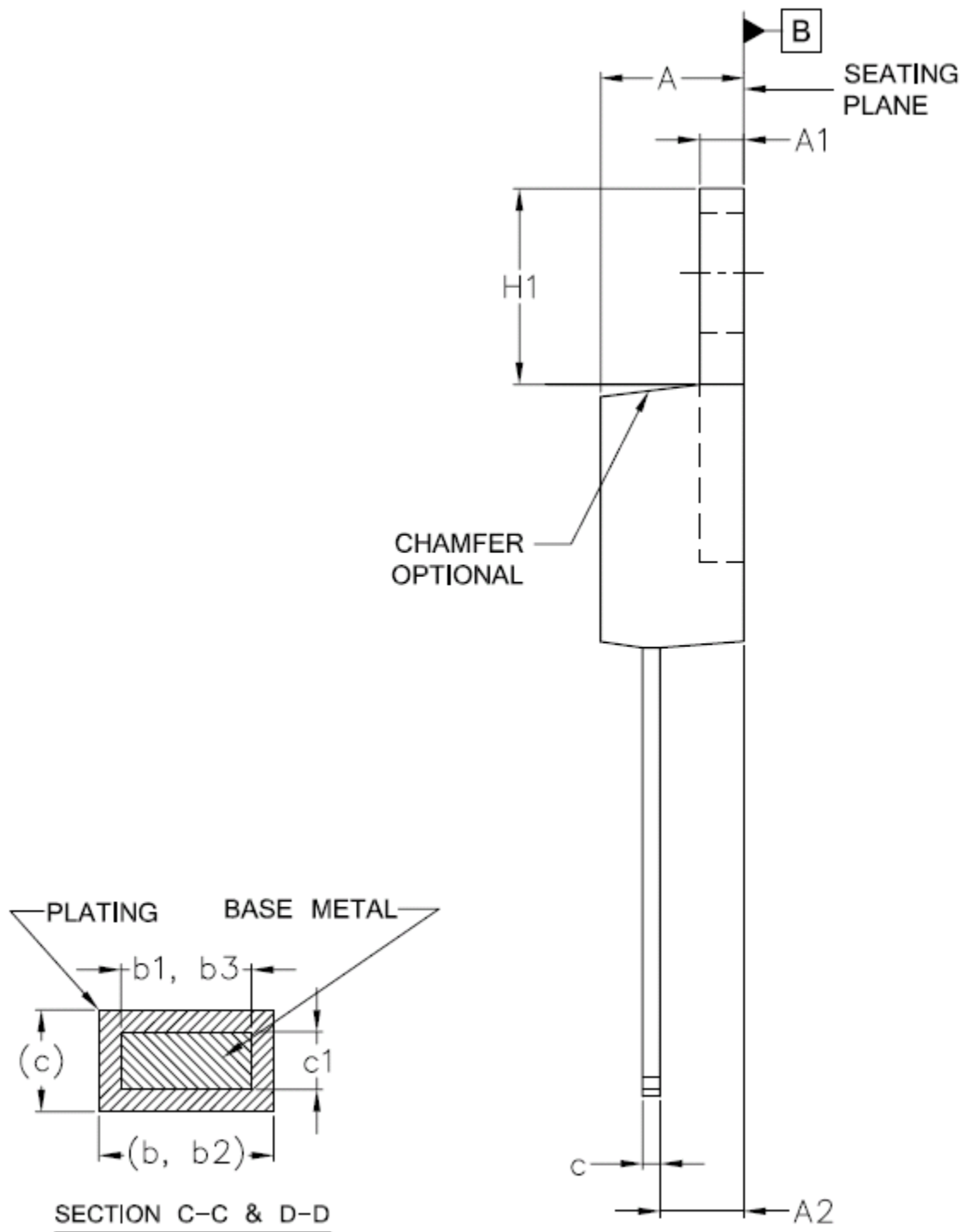

SYMBOLS	DIMENSIONS			
	mm		Inch	
	MIN.	MAX.	MIN.	MAX.
A	3.556	4.826	0.140	0.190
A1	0.508	1.397	0.020	0.055
A2	2.032	2.921	0.080	0.115
b	0.381	1.016	0.015	0.040
b1	0.381	0.965	0.015	0.038
c	0.356	0.610	0.014	0.024
c1	0.356	0.559	0.014	0.022
D	14.224	16.510	0.560	0.650
D1	8.382	9.017	0.330	0.355
D2	12.192	12.878	0.480	0.507
E	9.652	10.668	0.380	0.420
E1	6.858	8.890	0.270	0.350
e	2.540 BSC		0.100 BSC	
H1	5.842	6.858	0.230	0.270
L	12.700	14.732	0.500	0.580
∅P	3.810	3.860	0.150	0.151
Q	2.540	3.048	0.100	0.120
b2	1.143	1.778	0.045	0.070
R	1.270 BSC		0.050 BSC	
L1	–	6.350	–	0.250
b3	1.143	1.727	0.045	0.068
f1	3.200 REF.		0.126 REF.	
f2	4.220 REF.		0.166 REF.	
j	1.750 REF.		0.069 REF.	
r	0.510 REF.		0.020 REF.	
N	TO-220-3L			